

Keysight Technologies

4 Steps for Making Better Power Measurements

Application Note



Four Steps for Making Better Power Measurements

Before you select a power meter and its associated sensors, make sure that you have taken the following four steps, each of which can influence the accuracy, economy, and technical match to your application.

1. Understand the characteristics of your signal under test and how they interact with the power sensing processes.
2. Understand power measurement uncertainties, and traceability to a primary power standard at a national laboratory, such as the U.S. National Institute of Standards and Technology (NIST).
3. Understand the characteristics and performance of available sensor technologies and operating features of various power meters.
4. Make the performance comparison and select the right product for your application.

Even a cursory analysis will reveal that present power sensor technologies' have considerable overlap in capabilities. New system technologies, such as wireless modulation formats and their associated production test requirements, will often require some combined measurements such as time-gated peak parameters or computed data such as peak-to-average ratios. And you can be sure that all that data will be required at speeds that push the state of the art.

Your analysis might also include considerations of the installed base of other sensors and power meters in your organization's inventory. And, it should consider the traceability chain of your organization's metrology lab to national standards.

This application note will provide you with a brief review of the four factors that influence the quality of your power measurements. It will also offer other suggested information sources with more technical details, such as the Keysight Technologies, Inc. Application Note, AN 64-1C, *"Fundamentals of RF and Microwave Power Measurements,"* publication number 5965-6630E.

Power: The Fundamental RF and Microwave Measurement

Power measurement is the fundamental parameter for characterizing components and systems at RF and microwave frequencies. Above the range of 30 MHz to 100 MHz, where the parameters of voltage and current become inconvenient or more difficult to measure, microwave power becomes the parameter of choice. Power specifications are often the critical factor in the design, and ultimately the performance, of almost all RF and microwave equipment.

Power specifications are also central to the economic concept of equity in trade. This simply means that when a customer purchases a transmission product with specified power performance at a negotiated price, the delivered product must meet that specified power when installed and qualified at a distant location, perhaps in another country. Accuracy and traceability of your power instrumentation will help ensure this measurement consistency.

STEP 1.

Understanding Your Signal Under Test

A world of signal formats

System technology trends in modern communications, radar and navigation signals have resulted in dramatically new modulation formats, some of which have become highly complex. The objective of this section is to briefly examine a range of typical formats to see how their spectrum characteristics interact with various power sensor technologies.

Wireless and cellular systems depend on digital I-Q (inphase-quadrature) modulations at high data rates and other spread-spectrum formats. Because the final transmitted signal combines multiple carriers, statistical processes at work that can create extremely high peak power spikes, based on a concept called crest factor, described in the following paragraphs and in the section entitled "Digital and complex formats."

Wireless systems also contain frequency-agile local oscillators which "hand-off" the vehicle's signal as it moves from ground cell to ground cell and links up to each new base-station frequency. Sometimes the power perturbations, which occur during the frequency transition, need to be characterized.

Some radar and EW (counter-measures) transmitters have the traditional pulsed format, but many new systems also use spread-spectrum or frequency-chirped and complex phase-coded pulse configurations, which reveal more precise data on the unknown target returns.

Navigation systems such as the global positioning system (GPS) use complex phase-shift-keyed (PSK) formats to yield precision radiolocation. Other navigation systems use pulsed formats for distance or coded target identification.

Some signals under test are comprised of multiple test tones and others contain high harmonic content. Still others are generated by frequency-agile synthesizers, which can simulate entire, full-channel communications traffic formats. These test signals are used to characterize the real-life performance of transmitters and receivers such as satellite transponder systems.

To test overload and rejection characteristics of a receiver, composites of out-of-channel interference signals are created for use as test signals. Whenever such multiple signals are present, composite carriers can add random phases and create power "spikes". Thus, an application analysis is crucial to understand these effects on the power sensor.

In the sensor technology section (Step 3), much more detail is given to peak detection. Briefly, the measuring principle is that an averaging sensor responds to the average value of any format as long as the signal peaks remain within the sensor's square-law range. But driving ordinary diode sensors into their linear-detection ranges, even those with compensation techniques, will cause errors. Peak and average diode detectors, specifically designed for peak excursions, generally do not have problems with any type of complex signal format.

Pulsed formats

Some modern radars used narrower pulses that permitted better separation resolution of multiple targets. Their rise/fall times were proportionately shortened as well, and the bandwidth of the radar receiver increased. Then came other technologies for pulsing with longer phase-coded formats, which made it possible to determine factors such as the shape or size of a target. Multiple pulses and random pulse-repetition times are design strategies needed for resistance to countermeasures jamming.

All of these trends in pulse technology mean that specifying a measurement power meter requires a clear knowledge of the key parameters that need to be characterized. For some test sequences, measurement of the numerous pulse power and time parameters performed by peak power analyzers maybe needed. On others, the pulse top and average power will suffice.

Design and production tests for pulsed systems often require measurements of both peak pulse power (pulse top) as well as average power for the transmitter and other system components. Thermal sensors inherently respond to total average power, as long as the peak power excursions do not exceed the peak ratings of the sensor. And given a pulsed waveform with a fixed duty cycle (pulse width/total pulse period), its peak power can also be computed using the average power from a thermal sensor.

Diode-based sensors and associated power meters, which are designed for peak detection, are ideal when the pulse-top characterization is required, or when the pulse envelope must be profiled. These peak sensors feature wide-band amplification of the detected envelope, and permit digital signal processing (DSP) to measure and display the pulse shape and numerical parameters. Most modern radar and EW systems use complex and pseudo-random pulserate configurations for immunity to jamming, and thus can't use simple computations based on duty cycle. They require specific peak-type sensors.

When measuring peak power, it is important to understand the specific test requirements for characterizing the pulse parameters of a system or component. For example, measuring the rise time or fall time of a radar pulse might be crucial for testing the power amplifier component. The reason is that short rise/fall times correlate with higher bandwidth of the transmitted pulse and relate to its ability to resolve targets. Yet, in other production tests, perhaps on later subsystems, it may only be necessary to measure the pulse-top power of the pulse. By knowing the precise measurement specification required, a test engineer might use a simpler and less expensive power meter to determine that the subsystem is operating within its proper performance envelope.

Navigation systems such as air-traffic control (ATC) or distance-measuring transceivers (DME) also have nontraditional pulse configurations, such as pulse pairs or triplets. In that case, peak-detecting power meter/sensor combinations are appropriate, such as the Keysight E4416/17A meters and E9320A sensors as well as P-Series power meter N1911/12A and wideband power sensor N1921/22A.

AM/FM formats

Not many systems are active these days that are pure AM or FM, other than commercial broadcast, and perhaps amateur radio or "short-wave" formats. Frequency modulation, since its carrier amplitudes are relatively constant, can be measured with simple averaging power sensors. Amplitude modulation signals, on the other hand, must be analyzed to ensure that the peak modulation swings always remain below the limits of the sensor's "square-law" range, since the modulation peaks result in a $(V_{\text{carrier}})^2$ effect on power.

Digital and complex formats

Terrestrial communication

Terrestrial communication systems abound with design examples of the new digital phase modulation formats. Some early migrations to microwave terrestrial links from traditional FDM (frequency-division-multiplex), used 64QAM (quadrature-amplitude-modulation) formats.

Wireless and PCS

More recent wireless technologies combined digital formats with sophisticated carrier switching of transmitted signals to permit timeshared information from thousands of mobile subscribers, who were arrayed in cellular geographical regions.

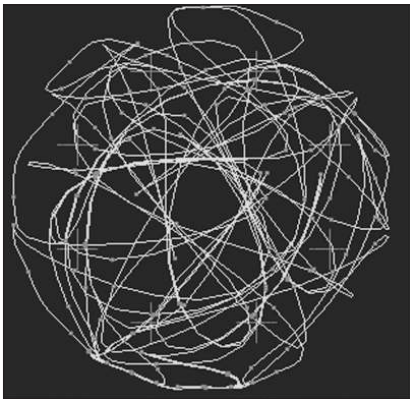

Figure 1. The 3/8 shifted-8PSK digital modulation format, emerging for use in wideband data transmission on wireless channels, as with EDGE technology.

TDMA (time division multiple access) is the technology for timesharing of the same base station channel. Encoded voice data and new high-data-rate wireless links are modulated onto the transmitted carrier in the phase plane. These create “constellations” of bit symbol locations such as shown in the $\frac{3}{8}$ shifted-8PSK configuration shown in Figure 1. This particular modulation format is used in EDGE (Enhanced Data Rates for GSM Evolution) systems that offer high-data-rate transfer over mobile wireless channels. By packing 3 bits per symbol, it increases data information rates, but thereby increases amplitude swings up to 16+ dB, making amplifier saturation more likely.

Each TDMA wireless subscriber’s share of time might allow a useful data burst of 524.6 μ S, during which it is crucial for the power amplifier to remain below its saturation region. Driving the output stage into non-linear amplification causes the outermost phase states to compress, thereby increasing bit errors and lowering system reliability.

Another competitive wireless modulation technology is called code division multiple access (CDMA), which is used in IS-95 wireless systems, among others. CDMA encodes multiple data streams onto a single carrier using a pseudo-random code, with a resulting transmitted power spectrum that exhibits almost white-noise-like characteristics.

But, just like white noise, the average power of the transmitted signal is only one of the important parameters. Because, statistically, multiple carrier signal voltages can increase randomly, instantaneous peak voltages can approach ratios of 10 to 30 times the rms voltage, depending on formats and filtering. This ratio, calculated with voltage parameters, is commonly called crest factor, and is functionally similar to a peak-to-average power ratio that is measured by the Keysight peak and average power meters.¹

System designers accommodate this crest-factor effect by “backing off” the power amplifiers from their maximum peak ratings to assure that signal peak power operation is always within their linear range.

1. Accepted definition of crest factor (pulsed carrier): The ratio of the pulse peak (voltage) amplitude to the root-mean-square (voltage) amplitude.

Two-tone and full-channel formats

Intermodulation tests

Two-tone (or three-tone) test signals are often used for characterizing amplifiers for linearity of their amplification. Amplifying two pure input signals of f_1 and f_2 results in intermodulation signals at the output, of the form $2f_1 - f_2$, $2f_2 - f_1$, $f_1 \times f_2$, and many more.

The measuring power of such tones needs analysis because the two carriers' phases add or cancel randomly over time. In a two-tone example of V_1 and V_2 , each with equal power P , the constructive addition of tones results in a peak carrier of $2V$ that is a peak power of $4P$. An average-responding sensor would indicate $2P$, but a peak-responding sensor would indicate $4P$.

Noise loading tests

Noise-loading tests of microwave amplifiers involve full-channel signals, simulated by an input of white noise, other than a single notched-out (slot-filter) carrier. If there is nonlinear amplification, the amount of intermodulation power in the notch at the output measures the performance of the amplifier.

There are also many examples of simple CW signal testing. Metrology laboratories provide typical applications, such as power sensor calibrators that are driven by CW test signals. Many component tests use simple unmodulated signals for test procedures.

These above examples are intended to illustrate that detailed knowledge of your unknown signal and its spectrum and modulation content is crucial to your selection of the best power sensor. In some cases, continuous wave (CW) and averaging sensors serve commendably. But other cases require precise characterization of the peak power performance to yield peak-to-average power ratios or time-gated parameters and ensure conformity to specified industry standards.

Step 2.

Understanding Measurement Uncertainties and Traceability to National Standards

The primary standard for an RF or microwave power measurement is a set of national power standards maintained by the U.S. National Institute of Standards and Technology (NIST) in Boulder, Colorado, U.S.A. Many other countries also maintain national power references and regularly perform comparisons with other standards laboratories in sophisticated measurement-assurance processes. These highly sophisticated power standards are called microcalorimeters (Figure 2) and are the basic reference for measurement services in coaxial and waveguide, with transfer techniques capable of achieving uncertainties of 0.42% at 18 GHz.

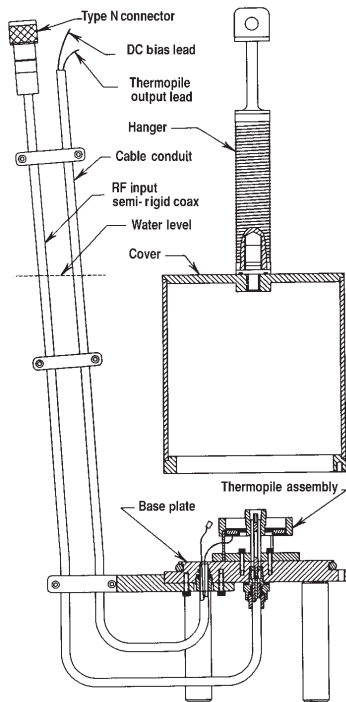

Figure 2. Schematic cross-section of the NIST coaxial microcalorimeter at Boulder, Colorado, U.S.A.

NIST and other national standards agencies offer fee-based measurement services for transferring such standards to customer primary labs. [1] [see reference literature] They include comprehensive documentation of the procedures, with fee schedules and application notes that provide detailed technical descriptions of the theory and practice of their measurement processes.

Keysight power instrumentation and sensor calibrations are traceable to those NIST standards, and to certain other national standards. Keysight performs its sensor production tests using automatic network analyzers for improved accuracy, by taking into account the complex reflection coefficients of each individual sensor. The sensors are furnished with calibration charts that include reflection coefficient as well as calibration factor data. With this individualized test data, the user can reduce measurement uncertainties introduced by sensor-to-source mismatch.

Measurement uncertainty standards

In recent years, the world's metrology and quality community has actively implemented a new process for calculating and reporting the uncertainties of measurement. The process is based on a standard promulgated by the International Standards Organization, Geneva, Switzerland, the ISO Guide to the Expression of Uncertainty in Measurement, often referred to as the GUM. [2] [see reference literature]

NCSL International (previously the National Conference of Standards Laboratories) in Boulder, Colorado, cooperating with the American National Standards Institute, adopted the ISO document as a U.S. National Standard, and introduced it in the USA as an industry document, ANSI/ NCSL Z540-2-1996, U.S. Guide to the Expression of Uncertainty in Measurement. [3] [see reference literature]

Both of the uncertainty standards operate within a larger metrology context, specified by ISO Guide 25, General Requirements for the Competence of Testing and Calibration Laboratories. This document was adapted for a U.S. version with the identical title, ANSI/NCSL Z540-1-1994.

Over the last several years, the ISO has replaced ISO Guide 25 with ISO/IEC 17025, and promulgated it internationally. In the U.S., the ANSI/ NCSLI Standards Writing Committee has recognized the advantage of a world-wide standard and adopted the ISO/IEC 17025 document as a U.S. National Standard in cooperation with the American Society of Testing Materials (ASTM) and the American Society of Quality (ASQ). To meet the needs of users who rely on the older ANSI/ NCSL Z-540-1-1994 standard, it has been officially extended for five years.

Measurement uncertainty standards (continued)

Because of its international scope of operations, Keysight has moved quickly to adopt ISO/IEC 17025 in lieu of its previous commitment to ANSI/NCSL Z-540-1. As a result, most of Keysight's production and support operations are moving to offer optional product-specific test data reports compliant with 17025. Option 1A7 will ensure compliance with 17025 for new products shipped from the factory and Keysight will provide for support re-calibrations to the same 17025-compliant processes, data and testing.

The new processes provide more rigor and standardization to the combined uncertainties of power parameters, from mismatching at measurement and calibration time to the traceability of the 50 MHz reference source. An extended explanation of the uncertainty calculation process is detailed in Chapter 7 of Keysight Application Note 64-1C *Fundamentals of RF and Microwave Power Measurements*, literature number 5965-6630E. In that example, 12 different uncertainty elements are combined.

Readers who are embarking on calculating measurement uncertainties, should recognize that the above-mentioned documents may seem simple enough in concept, and they are. But in the characterization of more complex instrumentation, the written specification uncertainties can often depend on multiple control settings and interacting signal conditions. Impedance bridges, for example, measure using complex number format. Network and spectrum analyzers have multi-layered specifications. Considerable attention is being expended to define and characterize these extensions of the basic GUM.

Generally, power measurement uncertainties are relatively straightforward. The dominant measurement uncertainties include sensor calibration factor uncertainty and the mismatch between the source under test and the sensor. For the E-Series sensors, Keysight provides temperature-banded calibration factor uncertainties. The two temperature bands are $25 \pm 10^\circ\text{C}$ and 0 to 55°C . These temperature ranges reflect a normal working environment (plus a guard band) and the full specified operating temperature range.

The smaller calibration factor uncertainties over $25 \pm 10^\circ\text{C}$ are therefore more realistic for R&D and manufacturing environments, and ultimately provide a lower overall measurement uncertainty. Other E-Series power sensor specifications that provide temperature-banded data are linearity and SWR.

Because the reflection coefficient of the test source is usually beyond the control of the user, it is desirable to choose power sensors with the lowest specified reflection coefficient. Keysight sensors are conservatively specified, and the actual reflection coefficient data for each sensor is furnished with the sensor. If, for example, in the sensor-specific calibration report, the reflection coefficient (Γ) value was 0.01 for a E9321A power sensor (at 1 GHz), then the SWR would be 1.02 (Return Loss -40 dB). This value could be used in the source/sensor mismatch calculation, refer to Chapter 7, "Measurement Uncertainty" in Application Note *Fundamentals of RF and Microwave Power Measurements*, literature number 5965-6630E. This SWR value would be in contrast to the warranted maximum SWR specification of 1.12 (at ≤ 0 dBm, for 1 GHz) contained in the Data Sheet *E4416A/E4417A EPM-P Series Power Meters and E-Series E9320 Peak and Average Power Sensor*, literature number 5980-1469E. Like the temperaturebanded calibration factor data, this value provides a lower overall measurement uncertainty.

STEP 3.

Understanding Keysight Sensor Technologies and Power Meter Features

In general, power sensors are designed to match user signal formats and modulation types. Similarly, power meters are designed to match the user's measurement data requirements. Sensor technology has developed over the years to better meet the advancing needs of users. The thrust has been to increase sensitivity and dynamic range, while improving the speed, accuracy, and reliability demanded by the fast-paced industry

Power sensors are of two general types:

1. Heat-based
2. Diode-detector based

Heat-based sensors such as thermistors and thermocouples depend on the process of absorbing all (except for tiny inefficiencies and reflections) of the RF and microwave signal energy, and sensing the resulting heat rise. Because the heat effect integrates all the signal power, such sensors are totally independent of the waveforms and spectrum content of the signal. Thus, they respond to the true average power of the signal, whether pulsed, CW, AM/FM, or other complex modulation, and account for spiked power effects such as crest factor.

Diode-based sensors depend on the rectifying characteristics of their non-linear microwave detection curve. Their ability to detect and measure power down to -70 dBm suits them for ultra-low signal detection

applications such as at the front end of RF or microwave systems. They are also ideal for wide-dynamic-range measurements. Also, they provide much faster response times, making them important for pulsed and high-data-rate applications.

While basic diode sensors operate in their "square-law" range from -70 to -20 dBm, Keysight has extended the diode technology into three other areas, extended-range CW sensors, two-path- diode-stack sensors for higher power, and peak and average sensors, which provide powerful pulse-power characterization. All will be described in this section.

Thermocouple technology

Keysight thermocouple sensors use a heat-based design with -30 dBm sensitivity and the highstability offered by a chopped-signal amplification path for the tiny DC signal generated by the thermal element. Keysight's silicon-web technology (circa 1974), which absorbs the RF/microwave heat and drives the silicon/metal thermocouple element, provides a major advance in improved impedance match (see Figure 3). This results in lower mismatch uncertainties and better measurement confidence. The chip also features a rugged termination design that withstands reasonable signal overloads.

Typical modern thermocouple sensors achieve wide frequency coverage with coaxial inputs, but some are configured in waveguides up to 50 GHz. With their dynamic power range of -30 to +20 dBm, they measure convenient ranges of system power common in industry.

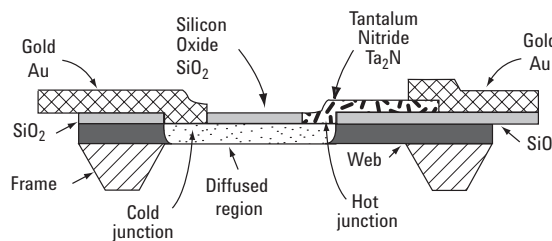

Figure 3. Cross section of Keysight thermocouple chip, where power dissipated in the tantalum-nitride resistor heats the hot junction.

Thermocouple technology (continued)

Thermocouple sensor accuracies depend on a precise 50 MHz reference power calibrator, which is resident in each power meter. Used in conjunction with an associated calibration factor, the meter/sensor combination then accurately transfers traceable power references to all frequencies of the sensor bandwidth.

Keysight has also extended the +20 dBm upper power range of several families of coaxial thermocouple sensors by including internal attenuators for 3-watt and 25-watt maximum inputs up to 18 GHz. Conveniently, the attenuator performance is included in the calibration factor data for better total accuracy.

The Keysight 8480A/B/H family of sensors typify this powerful thermocouple technology. Thermocouple sensors are recommended for all systems with CW, pulsed-power or complex modulations, because when the signal format lies within their dynamic range, you can be sure that the sensor is responding to total aggregate (average) power.

For some tests, however, such as a “mute” test on wireless power amplifiers (–55 dBm), limited sensitivity requires a second sensor to be used, increasing test times in some applications. In addition, measurements at the low-end of the specified range of thermocouple sensors (typically –25 to –30 dBm) sometimes require time-averaging to produce an accurate, stable reading.

Diode technology

Diodes convert RF/microwave to DC (or video in pulsed applications) by means of their rectification properties, which arise from their non-linear current-voltage characteristic. Figure 4 shows a typical diode detection response curve starting near the noise level of –70 dBm and extending up to +20 dBm.

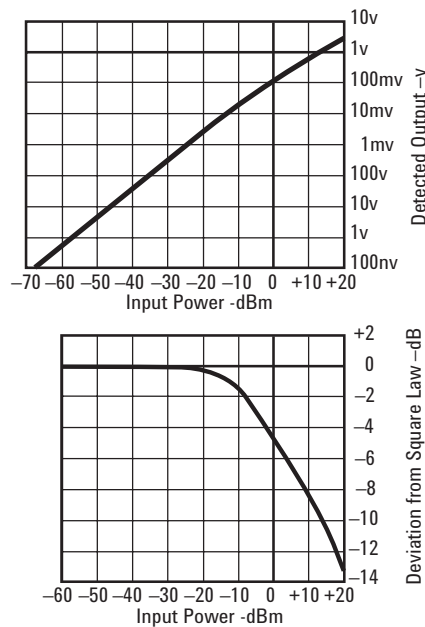

Figure 4. The diode detection characteristic is square law from the noise level up to –20 dBm, followed by a transition region and then a linear range to +20 dBm. The lower graph shows deviation from “square-law.”

In the lower “square-law” region the diode’s detected output voltage is linearly proportional to the input power (V_{out} proportional to V_{in}^2) and so responds linearly to power. Above –20 dBm, the diode’s transfer characteristic transitions toward a linear detection function (V_{out} proportional to V_{in}), and the square-law relationship is no longer valid. Traditionally, diode power sensors

have been specified to measure power over the –70 to –20 dBm range, making them the preferred sensor type for applications that require high-sensitivity measurements. In applications that require fast measurement speed, diode sensors are chosen over thermocouple types because of their quicker response to changes of input power.

Diode sensors (Keysight’s 8480D family) average the effects of complex and multiple signals within their square-law range from –70 to –20 dBm, with the proviso that no peak energy can exceed the –20 dBm level. This limits their use considerably for pulsed power measurement. The diode elements have also been designed into waveguide sensors, with coverage from 26.5 to 110 GHz (8486Series).

Extended dynamic-range diode sensors

Keysight diode sensor technology now permits measuring CW power over an extended dynamic range from –70 to +20 dBm, up to a frequency range of 33 GHz. Their 90-dB range makes them ideal for wide-dynamic range applications such as high-attenuation component measurements. When these sensors are used with the EPM Series power meters, they offer a fast measurement speed mode – up to 200 readings/second with the single channel E4418B meter.

These E4412/13A sensors employ a combination sensor-meter architecture, whereby the calibration factor is measured and stored in an EEPROM within each individual sensor, and downloaded into the meter. Because the correction factors are derived from a CW source, they do not provide an accurate average power reading for modulated signals, such as CDMA, when the signal peaks rise above the diode’s square law region.

Two-path diode-stack sensors

When power testing from -70 dBm up to $+20$ dBm is necessary, as has become increasingly the case, the traditional approach has been to use a diode sensor to cover the low range, and a thermocouple sensor for the high end. In a high-volume manufacturing environment, this dual measurement configuration consumes too much test time, especially if optimum accuracy must be maintained.

The ideal averaging sensor would combine the accuracy and linearity of a thermal sensor with the wide dynamic range of the extended diode approach. Keysight's E-Series sensors based on a patented dual-path, diode-attenuator-diode topology, have the advantage of always maintaining one of the two sets of sensing diodes within their square law region and therefore responding correctly to complex modulation formats.

The E-Series E9300 power sensors are implemented as a Modified Barrier Integrated Diode (MBID). The MBID is comprised of a two-diode-stack pair for the low power path, a resistive attenuator and a five-diode-stack pair for the high power path, as shown in Figure 5. Only one path is active at a time, and switching between paths is fast, automatic and transparent to the user, effectively producing an 80 dB dynamic range over -60 to $+44$ dBm, depending on the sensor model.

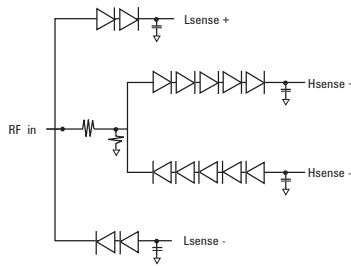

Figure 5. Simplified block diagram of the two-path-diode-stack topology.

This innovative approach has the important application advantage of enabling the sensor to handle higher power levels without damage, unlike simple diode sensors. This is particularly useful with W-CDMA signals, which exhibit high peak-to-average ratios.

These MBID sensors have a maximum average power specification of $+25$ dBm and $+33$ dBm peak (<10 μ s duration). This means that the full 80 dB dynamic range can be used to measure signals that simultaneously have both high peak power and high average power.

The new sensor technology facilitates an inherently broadband technique for measuring average power, without the bandwidth or dynamic-range trade-offs found with sampled techniques. These sensors are an ideal fit for users who need the flexibility to make wideband average power measurements.

The E9300 family of sensors cover the 6 and 18 GHz bands as shown in the product listings of Table 7, page 27. Optional coverage for the 6 GHz sensors extend to 18 GHz (Opt. H18 and H19), and for the 18 GHz products to 24 GHz (Option H24 and H25).

Together with the new E-Series E9300 power sensors, the companion Keysight EPM power meters (E4418B/19B) are capable of accurately measuring the average power of modulated signals over a wide dynamic range, regardless of signal bandwidth.

Peak and average power sensors

E9320 Series power sensors

The Keysight E9320 peak and average sensors presently cover the 50 MHz to 6/18 GHz frequency ranges and -65 to + 20 dBm power range. They are optimized for comprehensive measurements on pulsed envelopes and signals with complex modulation. When teamed with the new Keysight EPM-P Series power meters (E4416A/17A), the combination can handle test signal envelopes with up to 5 MHz video² bandwidth.

Of particular utility for production testing, the meters' 20 Msamples/second continuous sample rate permits fast measurement speed, via the GPIB, of up to 1,000 corrected readings per second, ideal for use in automatic test system applications.

Keysight peak and average sensor/meters feature two-mode operation, normal for most average and peak measurements (with or without time gating), and average only for average power measurements on low level or CW-only signals. Both modes use the same micro-circuit diode-sensor element.

The Keysight E9320 sensor family (using the EPM-P meter) can provide highly accurate and useful data for parameters such as pulse top or average power on pulses as narrow as 300 ns. While not specifically intended for narrow pulse characterization, its 5 MHz bandwidth amplifiers can deliver the measurements of Table 1. This capability is described further in the power meter section, page 19.

The signal processing is provided by two amplification paths, each optimized to their different data requirements. The amplification is distributed, with some in the sensor unit and more in the meter. In the average-only mode, amplification and chopping parameters are much the same as in previous Keysight diode sensors, with typical dynamic power range of -65 to +20 dBm.

2. Note that the video bandwidth represents the ability of the power sensor and meter to follow the power envelope of the input signal. The power envelope of the input signal is, in some cases, determined by the signal's modulation bandwidth, and hence video bandwidth is sometimes referred to as modulation bandwidth.

Bandwidth considerations

In the normal mode, the separate-path pulse amplifier provides maximum bandwidths of 300 kHz, 1.5 MHz or 5 MHz, defined by the sensor model number. This allows the user to match the test signal's modulation bandwidth to the sophisticated instrument data processing. For example, the three maximum bandwidth choices match up with these typical wireless system requirements:

| | |
|---------|-------------------|
| 300 kHz | TDMA, GSM |
| 1.5 MHz | CDMA, IS-95 |
| 5 MHz | W-CDMA, cdma2000® |

To further optimize the system's dynamic range, the video bandwidth can be user-selected inside the meter amplifier to high, medium, and low, as detailed in Table 2. Thus, when users need to measure the power of multiple signal types, within a single sensor, by considering the dynamic range of the bandwidth settings shown, they can determine if they require only one sensor or need multiple sensors for their application(s).

With peak power measurements, it is crucial to analyze the effect of the instrumentation video bandwidths on the accuracy of the resulting data. Keysight E4416 /17A meters have been optimized to avoid degrading key specifications like linearity, mismatch, dynamic range and temperature stability. For further information on this matter, see the following article, *"Power Measurements for the Communications Market."* [4] [see reference literature]

Measurement accuracy is enhanced without compromise, since the sensors store their three-dimensional calibration data in an EEPROM, resident in each sensor. The data is unique to each sensor and consists of cal factor vs. frequency versus power input versus temperature. Upon power-up, or when the sensor is connected, these calibration factors are downloaded into the EPM-P Series power meters.

(P-Series power sensors)

The Keysight N1921/22A P-Series peak and average power sensors provide wide-bandwidth power measurements over a frequency range of 50 MHz to 40 GHz with a dynamic range of -35 dBm to +20 dBm. When used together with P-Series power meters, they provide up to 30 MHz video bandwidth with 100 Msamples/ sec of continuous sampling, optimized for aerospace and defense, wireless communication, and wireless networking (IEEE 802.11a/b/g and 802.16e) applications. The fast sampling rate permits the fastest measurement speed among all Keysight power sensors, via GPIB, with up to 1,500 corrected readings per second. This rate optimizes production throughput, while at the same time improving the measurement accuracy.

The P-Series power sensors also have built-in EEPROM to store calibration factors and can download to power meters automatically once connected. They are also the first Keysight power sensors to provide "internal zero and calibration" while the sensor is still connected to device under test (DUT).

Table 1. E9320-Series sensors measuring pulse parameters.

| Key pulse parameter | EPM-P/E9320 specifications |
|---------------------------|----------------------------|
| Rise time | 200 ns |
| Fall time | 200 ns |
| Minimum pulse width | 300 ns |
| Pulse repetition rate | 2 MHz |
| Pulse repetition interval | 500 ns |

Table 2. E9320 sensor bandwidth versus peak power dynamic range (normal mode)

| Sensor model | Modulation bandwidth / Max. dynamic range | | | |
|---------------|---|---------------------------------|---------------------------------|--------------------|
| | High | Medium | Low | Off |
| E9321A/E9325A | 300 kHz / -42 dBm to +20 dBm | 100 kHz / -43 dBm to +20 dBm | 30 kHz / -45 dBm to +20 dBm | -40 dBm to +20 dBm |
| E9322A/E9326A | 1.5 MHz / -37 dBm to +20 dBm | 300 kHz / -38 dBm to +20 dBm | 100 kHz / -39 dBm to +20 dBm | -36 dBm to +20 dBm |
| E9323A/E9327A | 5 MHz / -32 dBm to +20 dBm | 1.5 MHz / -34 dBm to +20 dBm | 300 kHz / -36 dBm to +20 dBm | -32 dBm to +20 dBm |

The P-Series power sensors (N1921A and N1922A) provide internal zero and calibration which eliminates the need for sensor calibration using an external reference source. The P-Series sensors use Keysight's patented technology (see Figure 6) that integrates DC reference source and switching circuits into each of the sensors. Thus, users can zero and calibrate the sensors while they are still connected to the device under test. This feature removes the need for connection and disconnection from the calibration source, thereby reducing test times, measurement uncertainty, and wear and tear on connectors. It is especially useful in manufacturing and automated test environments where every second and every connection counts. Sensors can now be embedded within test fixtures without the need to switch a 50 MHz reference signal into the measurement path, or to provide isolation from signal sources for zeroing.

Keysight maintains a line of coaxial and waveguide thermistor sensors and one thermistor power meter. Thermistor sensors are heat-based, and exploit a balanced-bridge architecture using the DC substitution method. Thus, they are ideally suited for metrology-type applications such as transferring a reference power level from the primary standards of a national laboratory, or for an industry intercomparison process called a Round Robin.

The Keysight 432A power meter and associated 478/86 sensors and their role in traceability processes is fully detailed in Chapter 3 of Application Note 64-1C, *Fundamentals of RF and Microwave Power Measurements*, literature number 5965-6630E. Custom versions of the thermistor sensors, which feature selected low reflection coefficients, are available for the lower uncertainties they provide to reference power transfer applications.

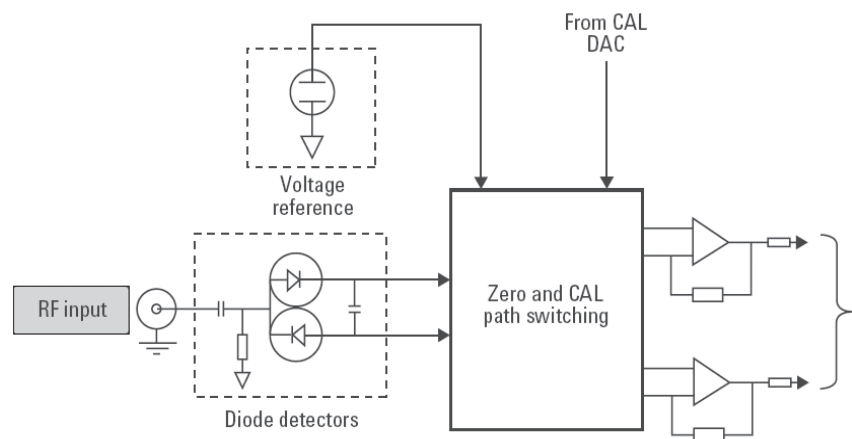

Figure 6. Internal zero and cal block diagram

Keysight power meters and USB power sensor

Keysight offers power meters in five basic families. (See Table 3.)

1. The P-Series N1911/12A for peak and average power measurements up to 30 MHz video bandwidth. They have the highest functionality, provide most versatile measurements and have the fastest measurement speed when used with the P-Series power sensors. They are also compatible with all Keysight diode and thermocouple sensors.
2. The E4416/17A Series for peak and average applications up to 5 MHz video bandwidth. They are backward compatible with all Keysight thermocouple and diode power sensors.
3. The E4418/19B Series for averaging power measurements. They offer full capabilities for average power applications, thus utilizing all but the E9320- and N1920-Series peak /average sensors.
4. The E1416A (VXI) system power meter is compatible with the 8480 Series sensors.
5. The 432A/478/486 thermistor family, which is preferred for metrology applications such as reference power transfer.
6. The U2000 Series USB power sensor for averaging power measurement. They offer full capability for average power measurement without the need for a separate power meter. This is a cost-effective solution that leverages the latest diode sensor technology.

Table 3. Keysight's family of power meters

| Keysight model | Name | Remarks |
|---|------------------------|--|
| Peak and average power meter P-Series | | |
| N1911A | Single-channel | Digital, programmable, peak and average measurements, uses N1921/22A sensors, With built-in CCDF measurements. Innovative time-gated pulse-power measurement up to 30 MHz video bandwidth. 100 Msamples/sec. |
| N1912A | Dual-channel | Two-channel version of N1911A, plus measures and computes parameters between the two sensors. |
| N8262A | Dual-channel | Modular power meter without front-panel with two-channel version of N1911A, plus measures and computes parameters between the two sensors. |
| Peak and average power meters EPM-P Series | | |
| E4416A | Single-channel | Digital, programmable, peak and average measurements, uses E9320 Series sensors. Innovative time-gated pulse-power measurements. 20 Msamples/sec. |
| E4417A | Dual-channel | Two-channel version of E4416A, plus measures and computes parameters between the two sensors. |
| Averaging power meters EPM Series | | |
| E4418B | Single-channel | Digital, programmable, uses E-Series and 8480 Series sensors, reads EEPROM-stored sensor calibration factors of E-Series sensors. |
| E4419B | Dual-channel | Two-channel version of E4418B, plus measures and computes parameters between the two sensors. |
| System power meter | | |
| E1416A | VXI power meter | Has functional performance features of previous model 437B; uses all 8480-Series sensors |
| Thermistor power meter | | |
| 432A | Thermistor power meter | DC-substitution, balanced-bridge technology, ideal for reference power transfers |
| Averaging power sensors U2000 Series | | |
| U2000A | USB power sensor | Digital programmable, average measurement without power meter. USB plug-and-play. Innovative time-gated pulsepower measurement. |

Peak and average meters (P-Series power meters)

The P-Series power meters and P-Series modular power meters have 30 MHz video bandwidth and a continuous sampling rate of 100 M samples per second for fast, accurate, and repeatable wide bandwidth power, time, and statistical measurements. When these meters are used with the P-Series wideband power sensors, they provide up to 40 GHz of frequency coverage, wide dynamic range, and extensive measurement capability optimized for aerospace and defense, wireless communications, and wireless networking (IEEE 802.11a/b/g) and 802.16e) applications.

With a sampling rate of 100 M samples per second, the P-Series power meters and P-Series modular power meters can capture singleshot as well as repetitive events over a wide bandwidth. For applications such as radar and pulse component testing that require accurate pulse measurements, the power meter and sensor combination has a 13 ns warranted rise and fall in time specifications.

With up to 30 MHz of video bandwidth, the P-Series also enables the single-instrument solution for testing wide bandwidth products such as the multi-carrier power amplifiers used in a 3G base station. The 30 MHz bandwidth is corrected to 0.1 dB flatness for high accuracy peak power measurements.

P-Series power meters and sensors and P-Series modular power meters offer comprehensive measurements that satisfy the requirements of many power applications in R&D and manufacturing:

1. Peak power, average power, and peak-to-average ratio power measurements
2. Time gated and free-run measurement modes
3. Automatic rise time, fall time, pulse width, pulse period, pulse repetition frequency, time to positive and time to negative transition occurrence measurements
4. Complementary cumulative distribution function (CCDF) statistics

Bandwidth considerations

The video bandwidths in the meter can be set to High, Medium, and Low or Off. The Off video bandwidth setting provides the fastest rise and fall time specifications. This is the recommended setting for minimizing overshoot on pulse signals. The high, medium and low settings are aimed at measuring wide bandwidth and modulated signals and are designed to provide a flat response across the bandwidth. There are also trade-offs which are made between bandwidth and dynamic range.

Figure 7 illustrates flatness response. The peak flatness is the flatness of a peak-to-average ratio measurement for various tone-separations for an equal magnitude two-tone RF input. Figure 7 shows the relative error in peak-to-average ratio measurements when the tone separation is varied.

Table 4. Dynamic response – rise time, fall time and overshoot, versus video bandwidth settings

| Video bandwidth setting | | | | | |
|-------------------------|------------|----------------|--------------|-----------|-----------|
| Parameter | Low: 5 MHz | Medium: 15 MHz | High: 30 MHz | Off | |
| | | | | < 500 MHz | > 500 MHz |
| Rise time/ fall time | < 56 ns | < 25 ns | ≤ 13 ns | < 36 ns | ≤ 13 ns |
| Overshoot | | | | < 5% | < 5% |

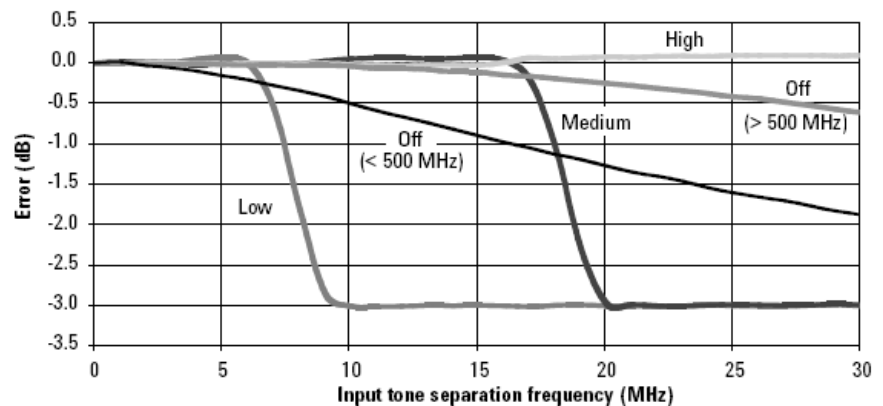

Figure 7. N192XA Error in peak-to-average measurements for a two-tone input (High, Medium and Low or Off video bandwidth)

Versatile user interface

The P-Series power meters have improved user interface and display control. The color screen has a high resolution trace display size of 320 x 240 pixels in the large display mode. This provides an attractive and clear trace display.

A numerical keypad has also been added. When combined with the new stylized arrow keys and central SELECT key, plus the standard hard key/soft key menu navigation, it helps to provide an intuitive and convenient user interface.

These interface features simplify the configuration of the meter for detailed measurements. A Save/Recall menu allows storage of up to ten instrument configurations for easy switching of test procedures.

The time-gated measurements are similar to the EPM-P Series where up to four independent gates can be setup to operate with different time lengths and delays.

Each gate can measure the three different parameters; average power, peak power or peak-to-average ratio. These gate measurements can be manipulated to compute combination measurements, such as F1 – F2 or F1/F2. This computational power is important in wireless communications where various computed parameters are required.

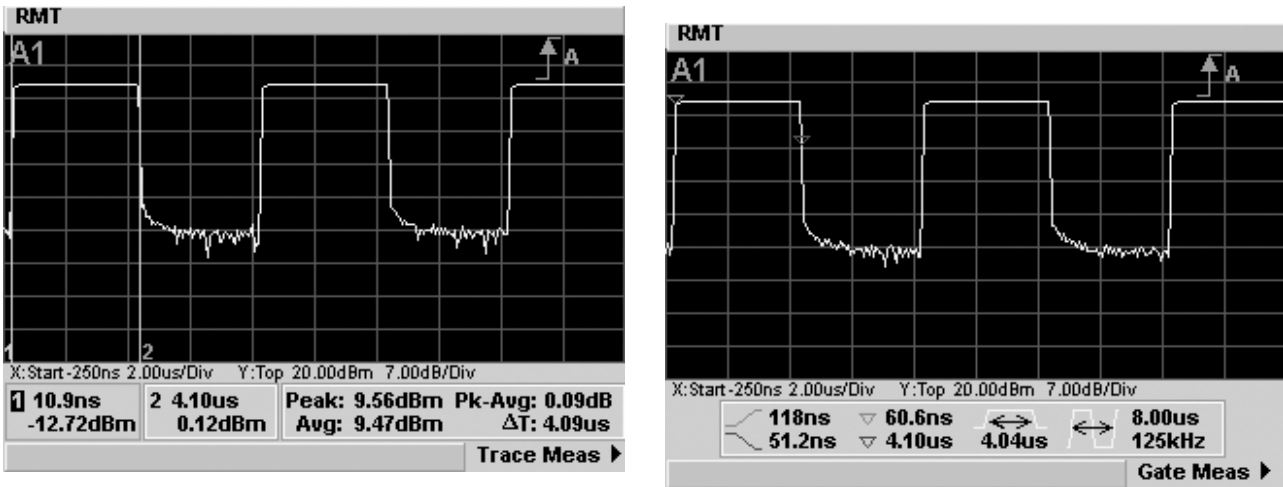

Figure 8. Large color display with automatic power and time measurements

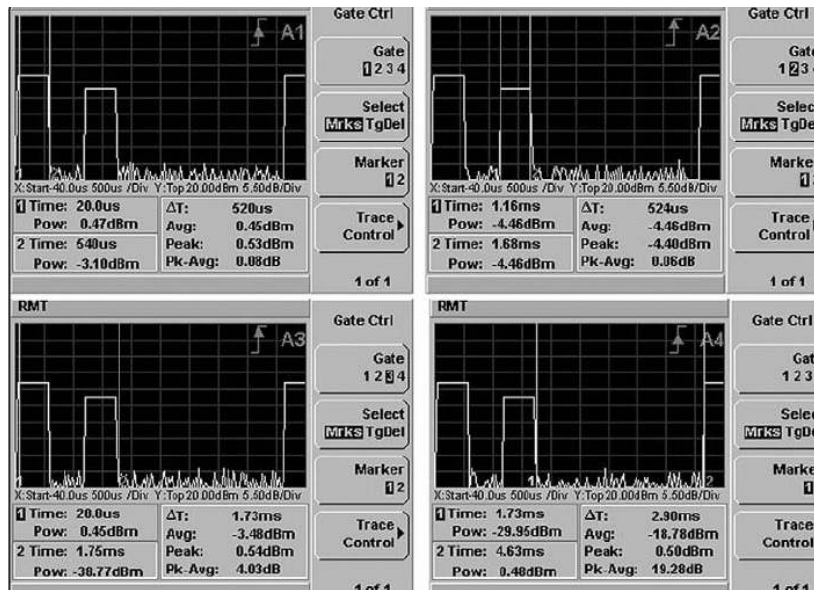

Figure 9. Measurement flexibility with four independent time gates

Flexible configurations

The P-Series products come with flexible configurations. Users can choose suitable configurations for their desired applications.

P-Series power meters

- N1911A single channel power meter, 9 kHz to 110 GHz (sensor dependent)
- N1912A dual channel power meter, 9 kHz to 110 GHz (sensor dependent)

P-Series modular power meters

- N8262A dual-channel power meter 9 kHz to 110 GHz (sensor dependent)

P-Series power sensors

- N1921A wideband peak and average power sensor, 50 MHz to 18 GHz
- N1922A wideband peak and average power sensor, 50 MHz to 40 GHz

The P-Series power meters and P-Series modular power meters are also compatible with Keysight 8480, E441x and E9300 Series average power sensors. This gives a selection of more than 30 sensors for peak and average power measurements over a wide dynamic range from -70 to +44 dBm, with a frequency coverage of 9 kHz to 110 GHz.

Pre-defined measurement setups

P-Series power meters are loaded with time saving features. Predefined test setups for common measurements (see Figure 10) used in radar and wireless communication applications allow easy meter setup for immediate testing. The meter also has LAN, USB, and GPIB connectivity as a standard feature to accommodate modern interfaces.

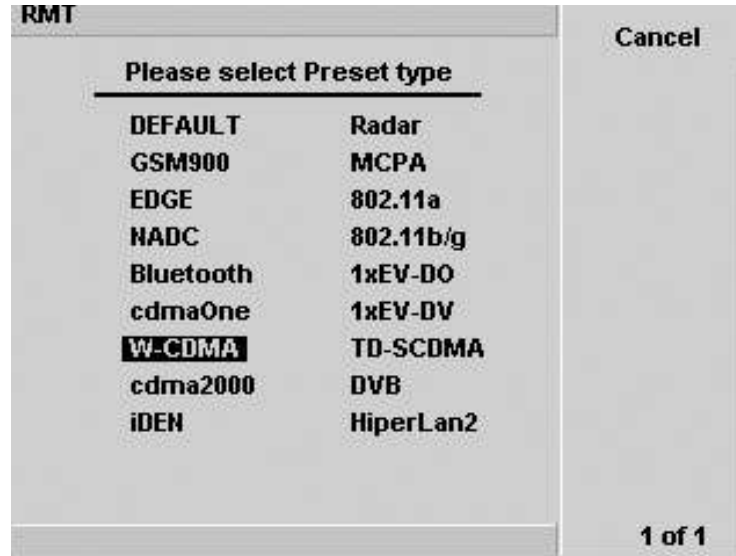

Figure 10. Pre-defined test setups

Measurements speed

When the P-Series power meters and sensors are used together, they provide the fastest measurement speed of all Keysight power meters. The measurement speed via remote interface is greater than 1,500 readings per second.

Table 5. Impressive GPIB measurement speed with P-Series power meters and sensors

| Sensor type | Measurement speed (readings/second) | | | |
|--------------------------------|-------------------------------------|-----|------|------|
| | Normal | x 2 | Fast | |
| N192xA power sensors | | | 1500 | |
| E9320 power sensors | Average only mode | 20 | 40 | 400 |
| | Normal mode | 20 | 40 | 1000 |
| E441xA and E9300 power sensors | 20 | 40 | 400 | |
| 8480 Series power sensors | 20 | 40 | N/A | |

P-Series soft front panel

The N8262A P-Series modular power meter has performance equivalent to that of the P-Series power meter bench instrument. The Keysight N8262A P-Series dual-channel modular power meter is very slim (see Figure 11) and supports LAN-based automated measurements. It is an LXI (LAN eXtensions for Instrumentation) Class-C-compliant instrument that combines the advantages of Ethernet with the simplicity and familiarity of GPIB. This helps the test system designers and integrators to create faster and more efficient systems.

The N8262A P-Series modular power meter comes with system-ready software such as:

- Instrument page that provides settings at a glance and enables remote access/control. (see Figure 12)
- User-familiar graphical user interface that provides P-Series N1911/12A front panel display emulation (see Figure 13)
- IVI drivers used for test software development that work with your choice of programming languages (Keysight VEE, LabView, Lab Windows, C, C++, C#, VB and Matlab)
- Optional PC analysis software: N1918A Power Analysis Manager for complex pulse analysis, statistical analysis, multi-channel analysis, recording and playback capability, and other features



Figure 11. N8262A P-Series dual-channel modular power meter

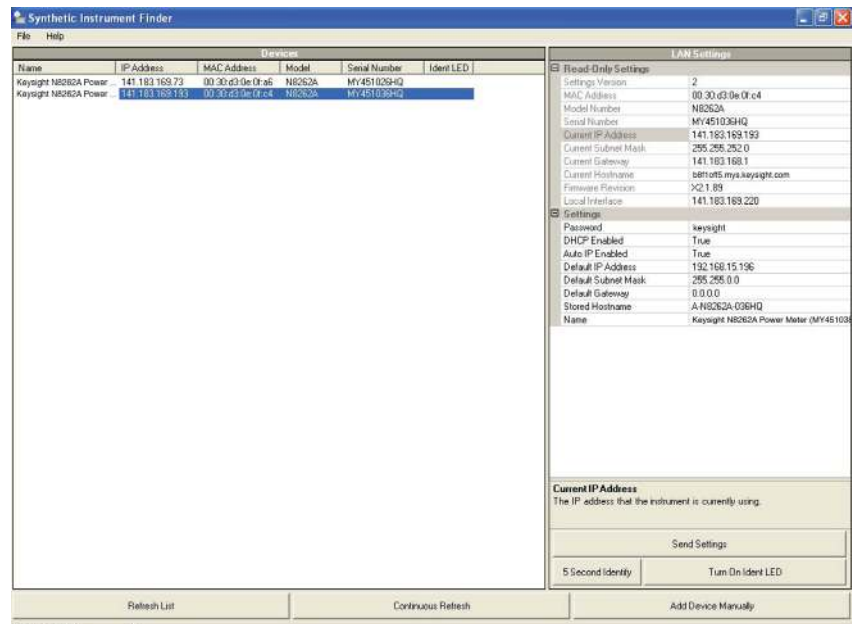

Figure 12. N8262A P-Series dual-channel modular power meter instrument page

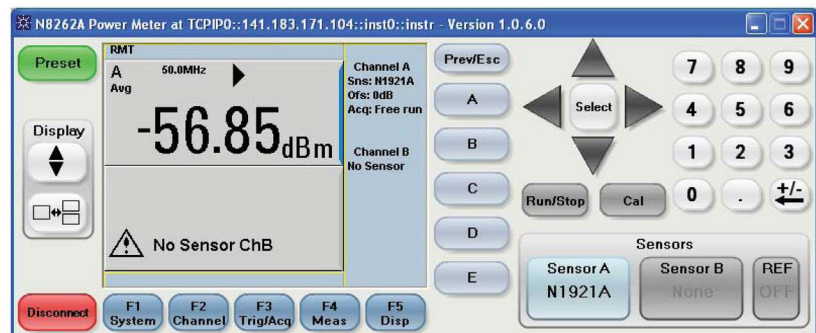

Figure 13. N8262A P-Series dual-channel modular power meter front panel display

EPM-P Series

The E4416/17A peak and average power meters (EPM-P Series) are cost efficient measurement tools for pulsed and complex modulation formats. In combination with the E9320 sensors, they feature a user-friendly interface and powerful display controls. (See Figure 14.)



Figure 14. E4417A power meter configured to show a trace display (upper window) and a dual numeric display (lower window).

Hardkeys control the most frequently used functions such as sensor calibration and triggering, while softkey menus simplify configuring the meter for detailed measurement sequences. A Save/Recall menu stores up to 10 instrument configurations for easy switching of test processes. And, in its GPIB programming mode, it can output up to 1,000 corrected readings per second.

A large LCD display partitions up to four-line formats to help interpret and compare measurement results, or presents large character readouts to permit viewing from a distance. For example, the four lines could be configured to display average power in dBm and mW, peak power and peak-to-average ratio. The user can also set up a trace display as shown in Figure 14.

Figure 16. This graphical display permits marker-selected power measurements, plus computations between the marker-identified data.

Powerful digital signal processing (DSP) mathematical processing permits the meter to measure burst average and peak power, to compute peak-to-average ratios, and display other time-gated pulse power profiles on the power meter's large LCD screen. The meters also measure and display other complex wideband modulation formats whose envelopes contain high frequency components up to 5 MHz.

For time-gated measurements, the EPM-P Series meters excel in versatility. The power meters measure peak and average powers at user-designated time-gates and gate widths along a test waveform. Figure 15 shows another typical time-gated power measurement on a GSM signal. Gate 2 provides the burst average power over the "useful" GSM time period and Gate 1 indicates the peak power over the complete timeslot. Thus, a peak-to-average ratio measurement can be obtained by subtracting Gate 1 - Gate 2 (in dB).

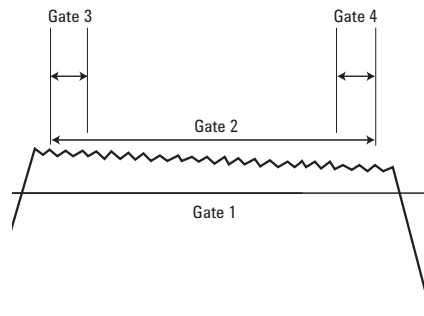
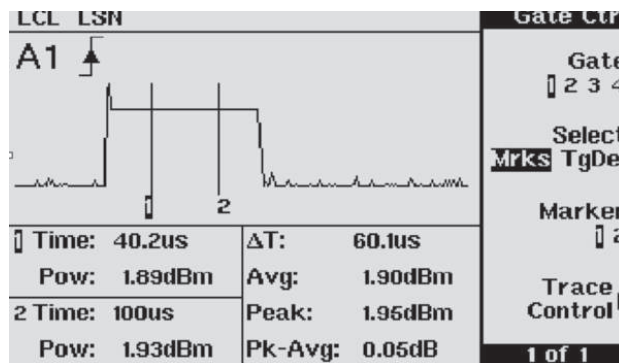

Figure 15. On this GSM pulse, powerful data configuration routines during four gate times, provide the feeds for the display.



This peak-to-average measurement made as shown, was using two different gate times and should not be confused with the peak-to-average ratio measurement in a single gate. A pulse drop measurement can be obtained from the subtraction of the two powers, Gate 3 – Gate 4. With the 4-line numeric display, all 3 of these measurements can be simultaneously display on the LCD screen, along with the peak power from Gate 1.

All EPM-P Series power meters now feature a firmware enhancement for a graphical trace setup and analysis screen. Figure 16 shows this new feature with real-time marker measurements on the meter's trace display. Markers 1 and 2 show the instantaneous power and time relative to a selected trigger event. On the right side are computational parameters of time, average, peak, and peak-to-average power ratios between markers 1 and 2. A trace-zooming capability is also available for more resolution on observations and settings.

VEE analysis package

Perhaps even more important to product development and verification engineers is a powerful analysis software package that totally controls the EPM-P meter from the PC or Laptop. This EPM-P VEE software package is available free of charge. It operates via the GPIB, and provides the statistical, power, frequency, and time measurements that are required for CDMA and TDMA signal formats. The CD-ROM package includes a VEE installation program.

The statistical package includes the ability to capture:

1. Cumulative Distribution Function (CDF)
2. Complementary CDF (CCDF or 1-CDF)
3. Probability Density Function (PDF)

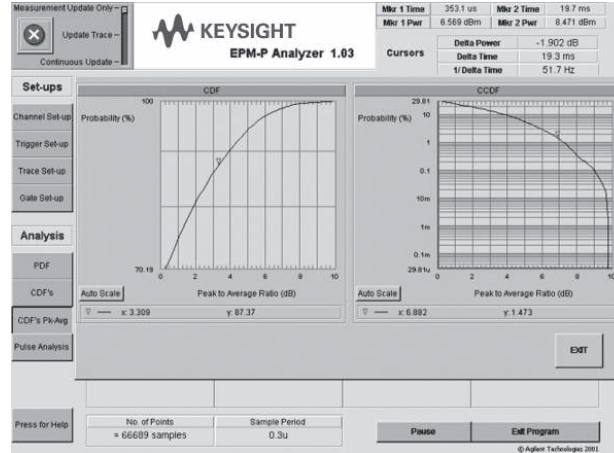

Figure 17. Y-axis shows the percent time the signal power is at or above the power specified by the X-axis.

These are crucial diagnostic parameters for system signals like CDMA formats. Figure 17 shows a typical distribution function display. Analyzing such power distribution computations can reveal how a power amplifier may be distorting a broadband signal that it is transmitting. A baseband DSP signal designer can completely specify the power distribution characteristics to the associated RF subsystem designers.

Finally, the analysis package includes a powerful pulse characterization routine. It computes and displays the following power parameters: pulse top, pulse base, distal, mesial, proximal, peak, average, peak/average ratio, burst average, and duty cycle. It does the same for these time and frequency parameters: rise time, fall time, pulse repetition frequency (PRF), pulse repetition interval (PRI), pulse width and off time. All of these pulsed power parameters were originally defined with the 1990 introduction of the Keysight 8990A peak power analyzer.

N1918A Power Analysis Manager

The N1918A Power Analysis Manager is PC-based application software that runs on the Microsoft Windows platform and aims to enhance the capabilities of some of Keysight's power meters and sensors. The N1918A can interface with various hardware devices, such as the N1911/12A P-Series power meter, N8262A P-Series modular power meter, and U2000 Series USB power sensors.

The N1918A Power Analysis Manager is a suite of software applications that comprises the basic version (Power Panel) and the advanced version (Power Analyzer). The Power Panel comes bundled with the purchase of U2000 Series USB power sensors, N1911/12A P-Series power meter, and N8262A P-Series modular power meter. The Power Panel offers an easy-to-use standard GUI for the hardware devices (see Figure 18).

The N1918A option 100, Power Analyzer is an optional licensed software solution that can be purchased separately. The Power Analyzer offers advanced functions that include pulse analysis, multichannel power measurement, statistical analysis, and recording. You can use this software to perform tests and measurements and track problems at any stage of the design process, from simulation to final prototype (see Figure 19).



Figure 18. Power Panel graphical user interface

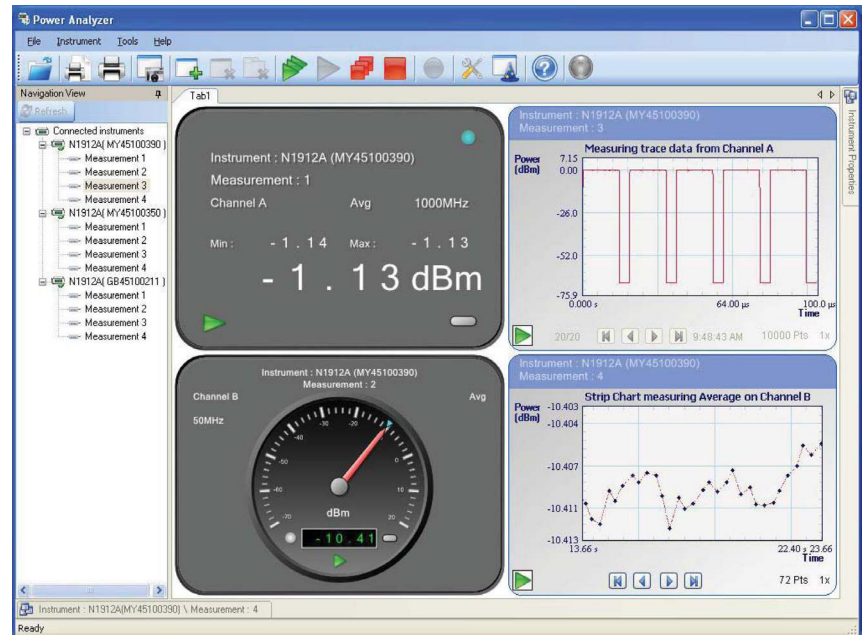

Figure 19. N1918A Power Analyzer

System power meter

Keysight offers the E1416A VXI power meter, for system applications in the industry-standard VXI configuration. The E1416A has the functional performance and operating features of the previous 437B power meter, except it has no front panel.

Basic computation power

By configuring the data obtained from the four gate periods, the E4416/17A meters can present computed data on their large LCD displays. For example, Figure 18 shows the data paths for the four independent gate periods. Each gate can accumulate three different parameters; average, peak, or peak-to-average ratio.

Each gate can then manipulate the selected parameter into two computed parameters (F-feeds) per measurement channel (maximum), such as F1 minus F2 or F1/F2, to be displayed in one of the four window partitions. This computational power is particularly valuable in TDMA scenarios such as GSM, GPRS, EDGE, and NADC where various simultaneous combinations of computed parameters are required.

This computational power is further enhanced in the E4417A dual-channel power meter, which can add data feeds from its second sensor into the user-configured display modes.

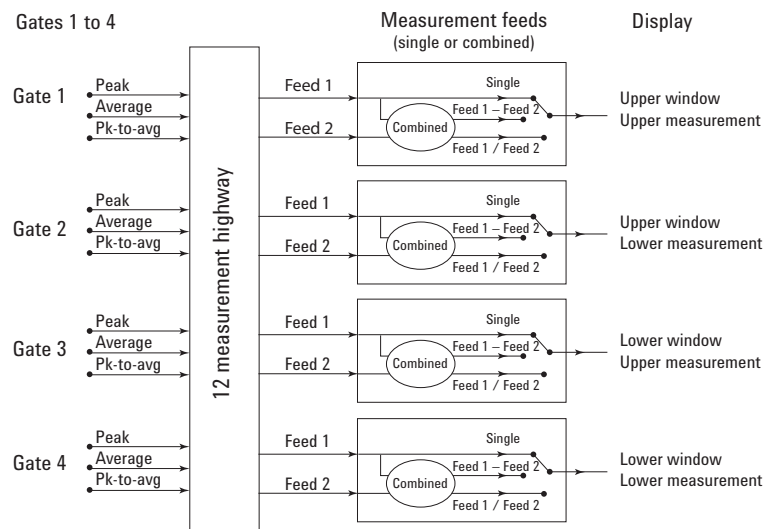

Figure 20. User-configured data manipulations: a major feature of the EPM-P Series power meters.

Averaging power meters (EPM Series)

Average power meters respond to all signals, whether CW, complex modulation or pulsed. The main application criteria is whether the user needs to characterize the modulation or profile the envelope of those pulse parameters or simply requires a measurement of average power. In some cases of traditional pulsed signals, where the duty cycle is known and fixed, system peak powers may be computed from a knowledge of the duty-cycle value and an average power measurement.

The E4418/19B power meters and E-Series sensor combination provides measurement speeds of up to 200 readings per second over the GPIB bus. The E-Series sensors cover a 90 dB power range from -70 to +44 dBm, with frequency coverage to 26.5 GHz, sensor dependent. For CW, multi-tone and modulation applications, the E-Series sensors can make measurements using only a single sensor rather than several of the 8480 Series as before.

Keysight EPM Series meters operate with the entire line of 8480 Series thermocouple and diode sensors, to protect your equipment investment. Programming code, written for the previous 436A, 437B and 438A power meters, is also directly usable with the E4418B and E4419B power meters.

Average USB Power Sensor (U2000 Series)

The U2000 Series USB average power sensor offers USB base connectivity via a PC plug-and-play port for power measurement. With the combined functionality of power meter and power sensor, a U2000 Series power sensor returns the power measurement readings and display on your PC via a USB cable. The power measurement reading can be retrieved using the standard SCPI commands or IVI.COM/IVI.C drivers. The feature-rich N1918A Power Panel software that comes with the purchase of the USB power sensor allows you to monitor the performance of the measurement and perform data logging without going through the programming guide.

The U2000 Series USB power sensor provides measurement speeds up to 250 readings/sec over USB cable. The USB sensor covers 80dB power range from -60 to +20dBm, with frequency coverage from 9KHz to 24GHz, sensor dependent. The U2000 Series consists of a built-in triggering circuit that enables measurement synchronization with the external instrument; even, for example, to control the timing of pulse-signal capture. For average burst power measurement, the U2000 Series USB power sensor can perform the time-gated average burst power measurement via its external triggering capability.

Low current consumption (approximately 170mA) enables a number of U2000 Series USB power sensors to be connected to a PC without the need of external USB hub to supply any additional power. No external power supply is required to power up the sensor because it uses the power from the PC's USB port.

STEP 4.

Comparing Performance and Selecting the Best Product for Your Application

By far, most power measurements are made with averaging power meters. Based on the previous comparison of sensor technology, and the selection guide for sensors (see next page), the user can easily determine which sensor model meets the power and frequency range performance required. The compatibility (Table 6) shows which meters operate with which sensors.

For averaging applications, the two EPM power meters are prime alternatives: Not only are they designed for the E-Series CW and E9300 sensors, but they are also backwards-compatible with the entire line of 8480 thermocouple and diode sensors (but not thermistors). Considering the large installed base of Keysight sensors in most organizations, this makes the EPM meters far more versatile and cost effective. Further, many calibration laboratories operate with test systems which are designed specifically to calibrate Keysight's long line of power sensors.

In spite of the popularity of averaging meters, the rapid growth of the wireless communications industry has driven measurement requirements into power characterizations of peak power, peak burst, peak-to-average ratio, burst average power, and other important parameters. Keysight provides three solutions for peak and average power measurements: the N1911/12A P-Series power meters, the N8262A P-Series power meters, and the E4416/17A EPM-P Series meters.

P-Series power meters and P-Series modular power meters provide innovative solutions to the stringent needs of the industry. These meters offer a wide bandwidth peak power with up to 30 MHz video bandwidth in your lab or on your production line. They are Keysight's most versatile and fastest meters, with a sampling rate of 100 Msamples per second. They are designed for pulse and radar component testing in the aerospace and defense market, as well as in wireless communication tests. The Keysight EPM-P power meters are a less costly solution for peak and average power measurements of up to 5 MHz video bandwidth with 20 M Samples per second of continuous sampling. They are optimized for wireless communication tests.

In the benchtop or production line environment, the choice is usually between single-channel and dual-channel capability. Keysight's meters can sense the specified power range of the individual sensor attached, and thus ensure the correct power readout. This feature also disables the readout if the user applies too much power and drives the meter outside the specified range, as with the standard 8480 Series diode sensors, which are limited to a top level of -20 dBm.

In terms of GPIB programming code, as well as complying to the Standard Commands for Programmable Instruments (SCPI), the E4418B power meter has been designed to be code-compatible with the previous 436A and 437B. The E4419B dual channel power meter is code-compatible with the previous 438A. This provides a substantial saving in new programming costs. The EPM Series power meters still offer flexibility, accuracy, and convenience for manual applications in the research lab.

For automated system use, the fast measurement speed, (EPM—200 readings per second, EPM-P—1,000 readings per second, P-Series—1,500 readings per second) make them ideal for programmed applications. Their digital-signal-processing (DSP) circuit architecture not only provides for powerful computation and averaging routines, but also results in the elimination of the standard range switch-time delays, thus speeding up the overall measurement speed.

Thermistor-based sensors and meter for metrology applications

Finally, Keysight offers a line of coaxial and waveguide thermistor sensors and a full DC-substitution power meter, the 432A, which serves metrology applications for the transfer of power standards.

Selection guides

Power measuring equipment for all applications

Power measuring equipment is a key part of Keysight's instrumentation line of RF and microwave measurement tools. Through the decades, the power-meter line has advanced by adding the power of the newest sensor technology and harnessing the power of the microprocessor for more capable and flexible power meter products.

From the original drift-prone thermistor sensors of the 1950s, to low-SWR thermocouple sensors, Keysight has exploited the latest technologies to take the inaccuracies out of your power measurements. The latest sensor technologies that use planardoped-barrier diodes in various configurations now offer the best in sensitivity and low drift for both average-power and peak-power measurements. And Keysight's newest P-Series power meters and sensors give you improved speed and accuracy for measurements over a dynamic range of -70 to $+44$ dBm, with sensor dependent, auto zero, and calibration capability.

The latest technology of Keysight power sensor, U2000 Series USB power sensor, allows power measurement on a PC via plug-and-play USB port and without the need for a separate power meter.

Table 6 presents a compatibility overview of the entire Keysight power measurement family, including meters and sensors.

Table 6. Keysight power meter/sensor compatibility chart

| Keysight power sensors | Keysight power meters | | | | | P-Series modular peak, average, and time gating N8262A dual Ch |
|---|---|---|--|--------------------|-----------------------------|--|
| | P-Series peak, average, and time gating N1911A single Ch N1912A dual Ch | EPM-P Series peak, average, and time gating E4416A single Ch E4417A dual Ch | EPM Series averaging E4418B single Ch E4419B dual Ch | System power meter | Thermistor power meter 432A | |
| Thermocouple 8480A/B/H-family R/Q8486A W/G (11 models) | • | • | • | • | | • |
| Diode 8480D-family 8486A/D-W/G-family (7 models) | • | • | • | • | | • |
| Diode sensors with extended range E4421A/13A (2 models) | • | • | • | | | • |
| Two-path-diode-stack E9300A family (7 models) | • | • | • | | | • |
| Peak and average sensors, E9320 family (6 models) | • | • | | | | • |
| Thermistor sensors 478 coaxial 486 waveguide (6 models) | | | | | • | |
| Peak and average sensors N1921/22A (2 models) | • | | | | | • |
| Two-path-diode-stack U2000-family (4 models) | <power measurement without separate power meter> | | | | | |

Keysight's family of versatile sensors

Table 7. Keysight's family of power sensor

Thermocouple sensors

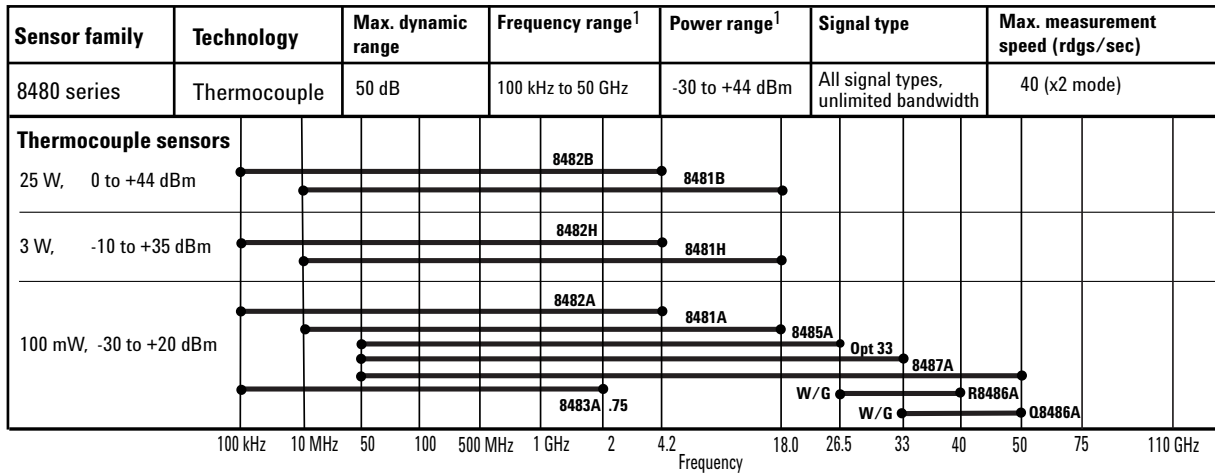

Diode sensors

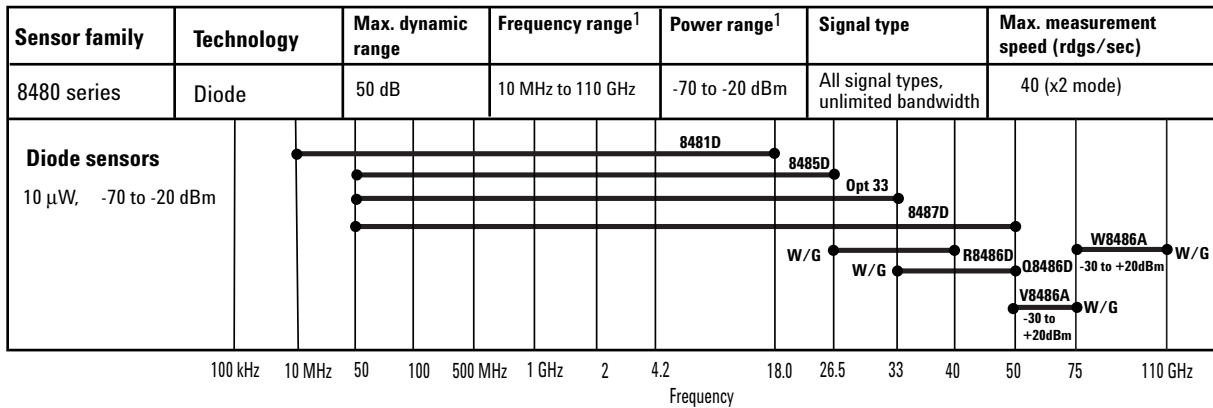

Extended-range diode sensors

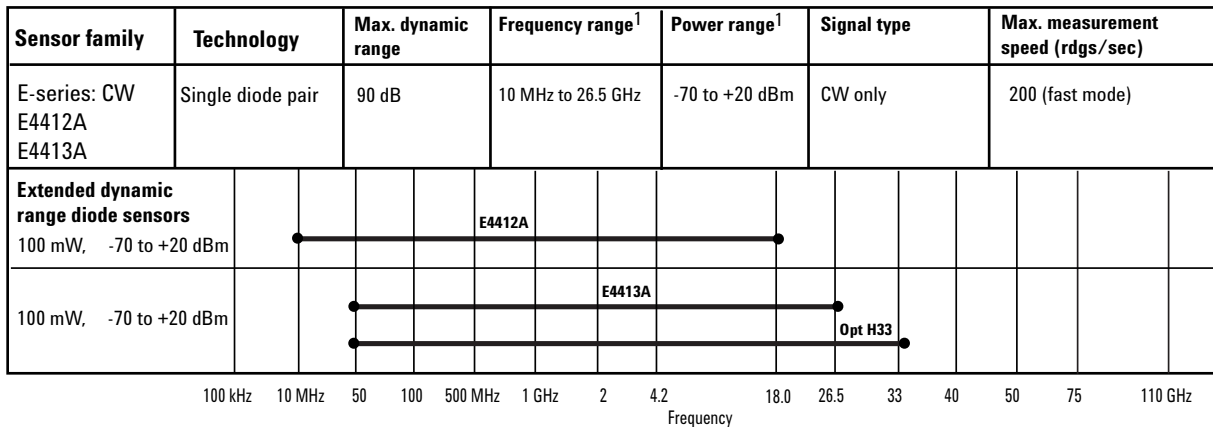

1. Sensor dependent

Two-path diode stack sensors

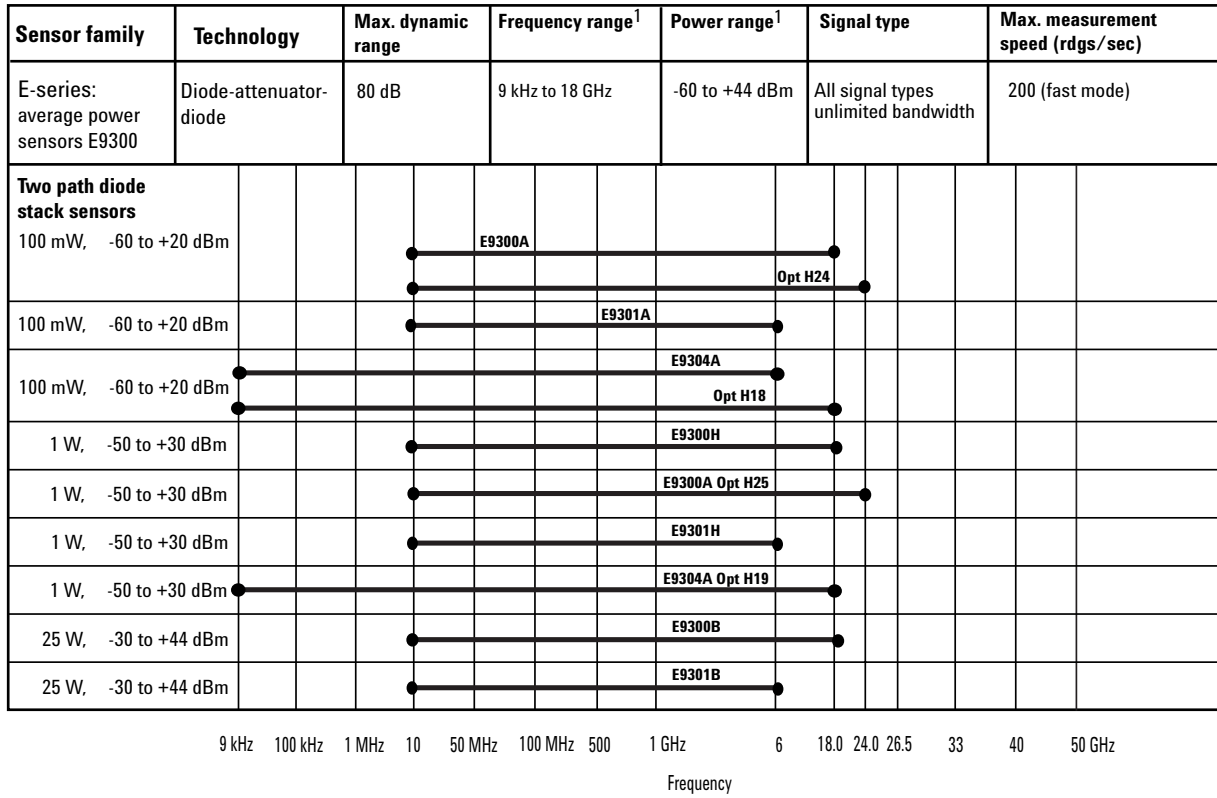

U2000-Series average power sensor

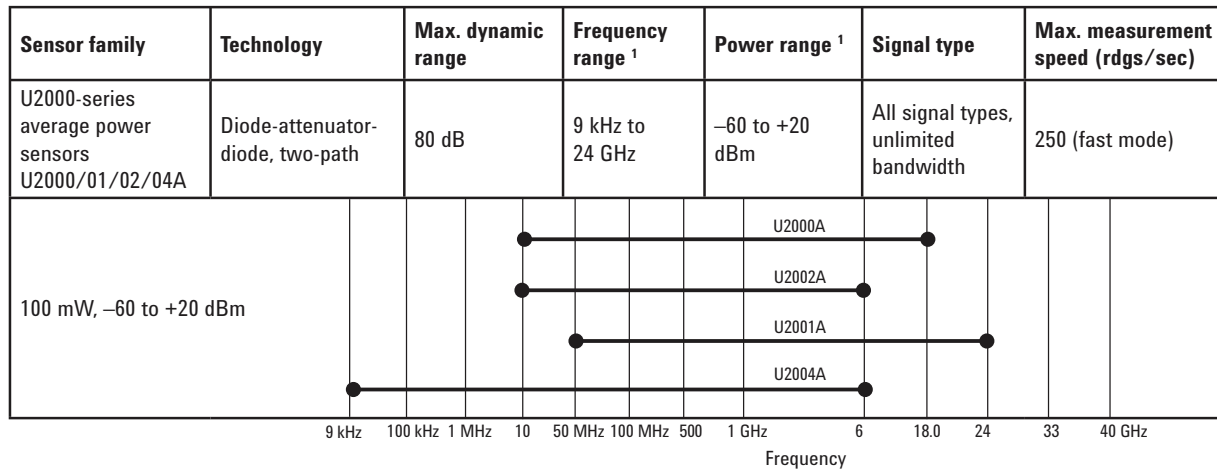

1. Sensor dependent

Peak and average sensors (up to 5 MHz video bandwidth)

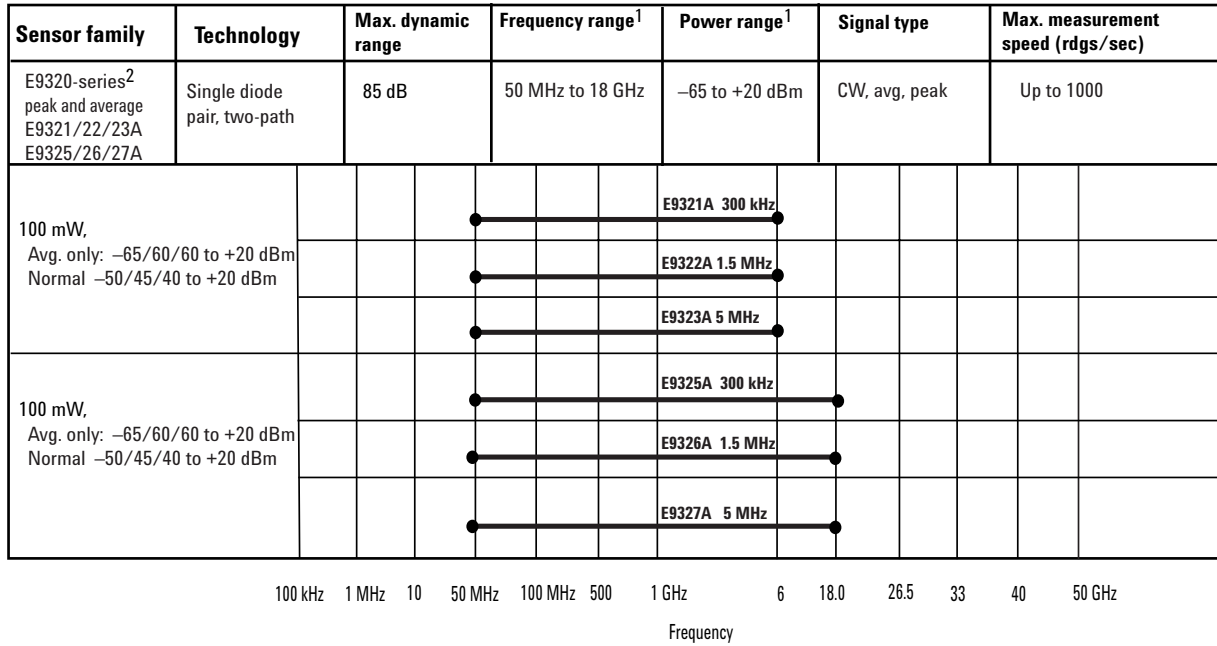

Peak and average sensors (up to 30 MHz video bandwidth)

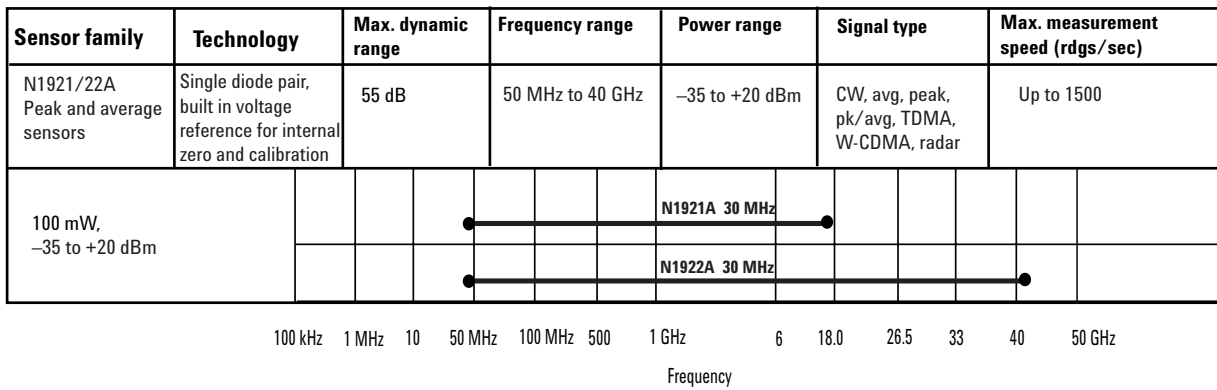

1. Sensor dependent
 2. Peak and average sensors must be used with an E9288A, B, or C sensor cable, and only operate with the E4416A/17A power meters

References

1. A Calibration Service for Coaxial Reference Standards for Microwave Power, Claque F.R., NIST Technical Note 1374, NIST, 325 Broadway, Boulder, Colorado, USA, May 1995
2. International Organization for Standardization, Geneva Switzerland, ISBN 92-67-10188-9, 1995
3. National Conference of Standards Laboratories, Boulder, CO, ANSI/ NCSL Z540-2-1996
4. Anderson, Alan, Power Measurements for the Communications Market, MW/RF Magazine, October 2000

For more information:

- *Choosing the Right Power Meter and Sensor, Product Note*, literature number 5968-7150E
- *Fundamentals of RF and Microwave Power Measurements, Application Note 64-1C*, literature number 5965-6630E

Related Keysight literature

- *EPM-P Power Meters and the E9320 Series Power Sensors, Technical Specification*, literature number 5980-1469E
- *EPM and EPM-P Series Power Meters and E-Series Power Sensors, Configuration Guide*, literature number 5965-6381E
- *EMP-P Series Single and Dual-Channel Power Meter-E9320 Family of Peak and Average Power Sensors, Product Overview*, literature number 5980-1471E
- *EPM Series Power Meters, E-Series and 8480 Series Power Sensors, Technical Specifications*, literature number 5965-6382E
- *EPM Series Power Meters, Product Overview*, literature number 5965-6380E
- *E9300 Power Sensors, Product Overview*, literature number 5968-4960E

- CD-ROM: EPM and EPM-P Series Power Meters, part number E4416-90032

This CD-ROM contains the power meters and sensors Learnware (User's Guides, Programming Guides, Operating Guides and Service Manuals). The CD-ROM also contains technical specifications, data sheets, product overviews, configuration guide, application and product notes as well as power meter tutorials, analyzer software for the EPM-P power meters, IVI-COM drivers, IntuiLink toolbar for the EPM power meters and VXI Plug & Play drivers for the EPM power meters.

This versatile CD-ROM package is shipped free with every EPM and EPM-P power meter.

Additional information is also available at: www.keysight.com



myKeysight

www.keysight.com/find/mykeysight

A personalized view into the information most relevant to you.

cdma2000 is a US registered certification mark of the Telecommunications Industry Association.

This document was formerly known as Application Note 64-4D.

For more information on Keysight Technologies' products, applications or services, please contact your local Keysight office. The complete list is available at: www.keysight.com/find/contactus

Americas

| | |
|---------------|------------------|
| Canada | (877) 894 4414 |
| Brazil | 55 11 3351 7010 |
| Mexico | 001 800 254 2440 |
| United States | (800) 829 4444 |

Asia Pacific

| | |
|--------------------|----------------|
| Australia | 1 800 629 485 |
| China | 800 810 0189 |
| Hong Kong | 800 938 693 |
| India | 1 800 112 929 |
| Japan | 0120 (421) 345 |
| Korea | 080 769 0800 |
| Malaysia | 1 800 888 848 |
| Singapore | 1 800 375 8100 |
| Taiwan | 0800 047 866 |
| Other AP Countries | (65) 6375 8100 |

Europe & Middle East

| | |
|----------------|---------------|
| Austria | 0800 001122 |
| Belgium | 0800 58580 |
| Finland | 0800 523252 |
| France | 0805 980333 |
| Germany | 0800 6270999 |
| Ireland | 1800 832700 |
| Israel | 1 809 343051 |
| Italy | 800 599100 |
| Luxembourg | +32 800 58580 |
| Netherlands | 0800 0233200 |
| Russia | 8800 5009286 |
| Spain | 800 000154 |
| Sweden | 0200 882255 |
| Switzerland | 0800 805353 |
| | Opt. 1 (DE) |
| | Opt. 2 (FR) |
| | Opt. 3 (IT) |
| United Kingdom | 0800 0260637 |

For other unlisted countries:
www.keysight.com/find/contactus
(BP-09-23-14)

