

# pc<sup>o</sup>.panda 4.2 bi

ultra compact **sCMOS** camera

**bi** back illuminated

lightsheet scanning mode

low light mode

up to **95 %**  
quantum efficiency

back illuminated  
**sCMOS** sensor

**USB 3.1**  
interface

**resolution**  
2048 x 2048 pixels  
with 6.5  $\mu\text{m}$  pixel size



**65 mm**

ultra  
**compact**  
design

**input windows**  
selectable

**single cable solution**  
data & power supply via USB 3.1

**1288**   
EMVA Standard Compliant

# pc<sup>o</sup>.

» sCMOS image sensor

type of sensor	backside illuminated scientific CMOS (bi sCMOS) monochrome
resolution (h x v)	2048 x 2048 active pixels
pixel size (h x v)	6.5 µm x 6.5 µm
sensor format / diagonal	13.3 mm x 13.3 mm / 18.8 mm
shutter mode	rolling shutter (RS) additional feature: <b>lightsheet scanning mode<sup>1</sup></b>
MTF	76.9 lp/mm (theoretical)
fullwell capacity	48,000 e <sup>-</sup> 1,800 e <sup>-</sup> <b>low light mode</b>
readout noise (typ.) <sup>2</sup>	1.8 med e <sup>-</sup> / 1.9 rms e <sup>-</sup> 1.1 med e <sup>-</sup> / 1.2 rms e <sup>-</sup> <b>low light mode</b>
dynamic range (typ.)	26 667 : 1 (88.5 dB) 1636 : 1 (64 dB) <b>low light mode</b>
quantum efficiency	up to 95 %
spectral range	370 nm ... 1100 nm 190 nm ... 1100 nm <b>UV version</b>
dark current (typ.)	42 e <sup>-</sup> /pixel/s @ 21 °C ambient temperature
DSNU	0.9 rms e <sup>-</sup> 0.4 rms e <sup>-</sup> <b>low light mode</b>
PRNU	1.1 % 1.4 % <b>low light mode</b>
anti blooming factor <sup>3</sup>	> 10 000

<sup>1</sup> Selectable via SDK (software development kit).

<sup>2</sup> The readout noise values are given as median (med) and root mean square (rms) values, due to the different noise models, which can be used for evaluation. All values are raw data without any filtering.

<sup>3</sup> Based on image sensor datasheet.

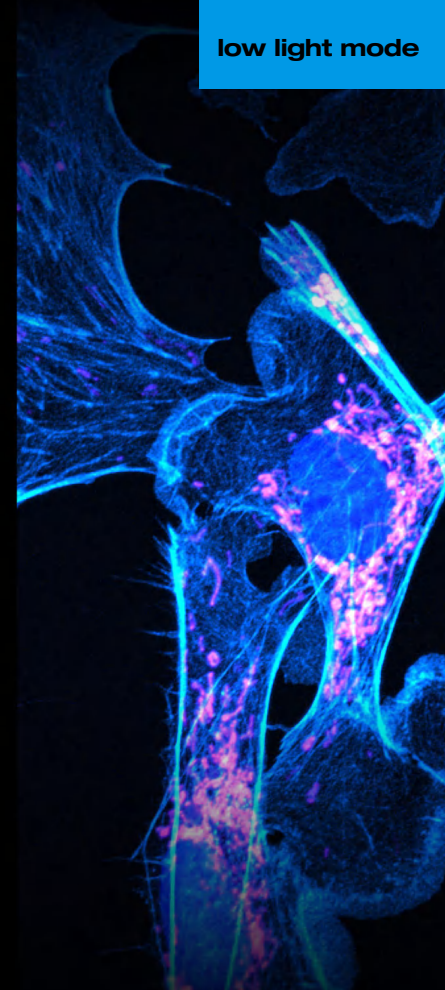
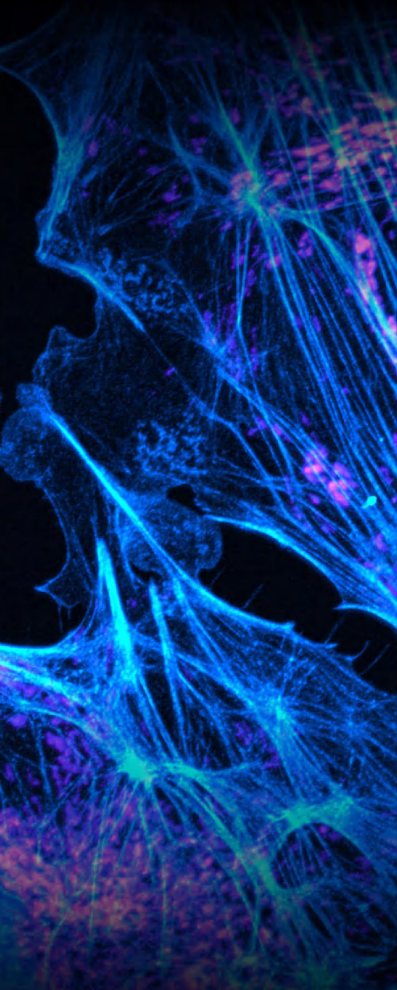

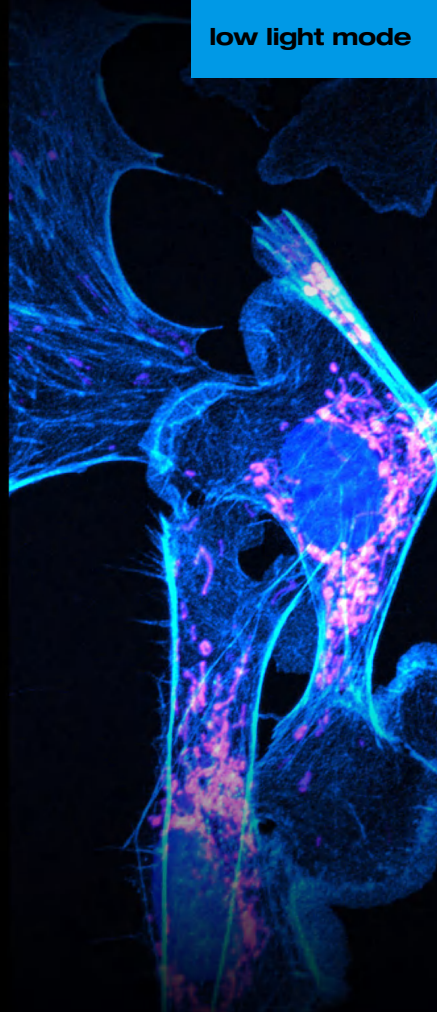
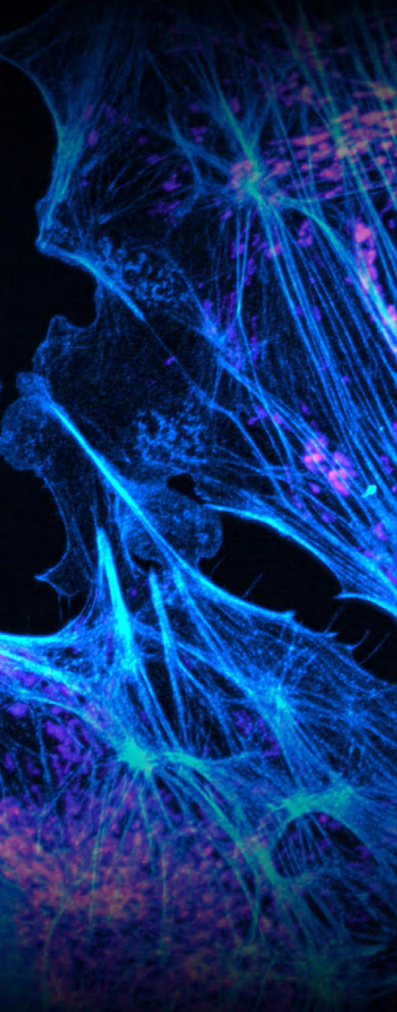

**low light mode**

When the low light mode is activated, both the high and low gain A/D converter are used as high gain, which means they digitize low intensity pixel values only.

The signal within each pixel is simultaneously digitized by two separate A/D conversion units and added up, which is referred to as correlated multi sampling (CMS). This correlation causes a major reduction of the readout noise, though the usable intrascene dynamic range of the sensor is reduced.

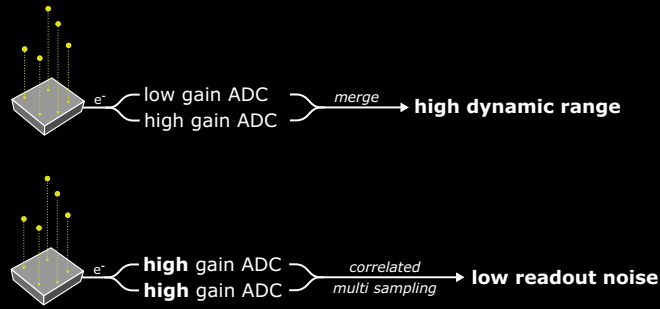

**lightsheet scanning mode**

The PCO lightsheet scanning mode is a special readout mode dedicated to lightsheet microscopy. It is based on the rolling shutter mode in which the readout direction of the sensor is from top to bottom.

The standard line time value is 12  $\mu$ s and it can be set from this camera-specific line time up to 2 ms. Compared to the standard operation mode, the lightsheet scanning mode enables the selection of the parameters "Line Time" and "Exposure Lines". This guarantees an optimized synchronization to an existing lightsheet setup which has no selectable speed or timing. It is possible to set a delay prior to the exposure start ("delay lines").

For more information on the corresponding SDK functions, please read our pco.sdk instruction manual.

selectable parameter:  
(only via SDK)

$T_x$  Line Time (12  $\mu$ s ... 2 ms)  
 $L_x$  Exposure Lines (1 ... 2048)

Start Exposure  
End Exposure

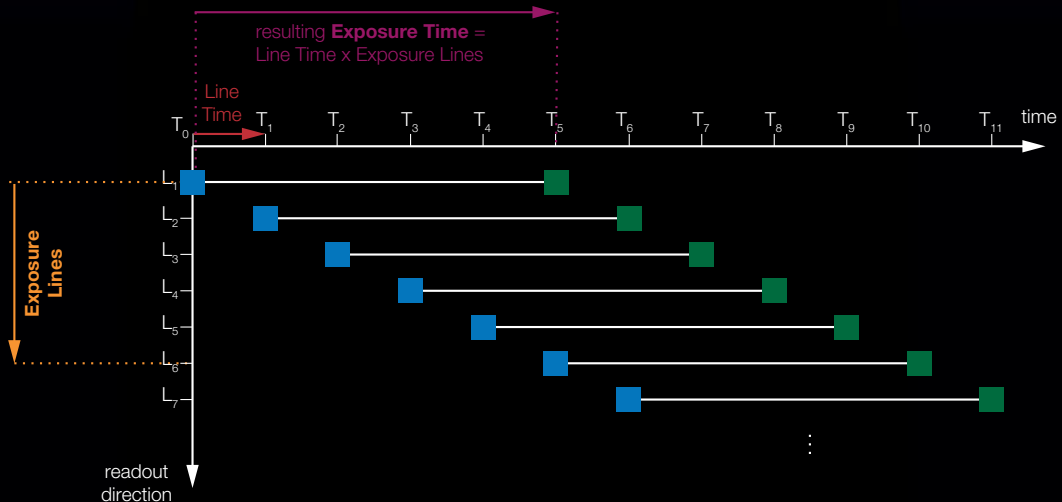

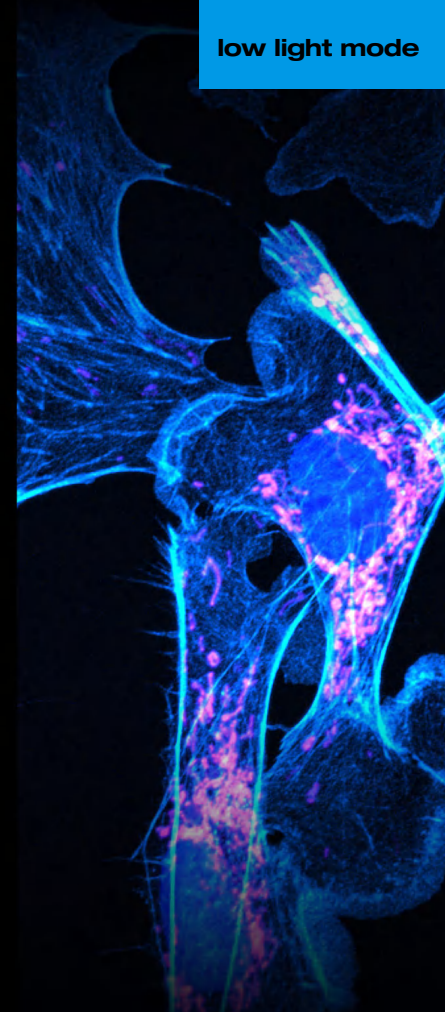
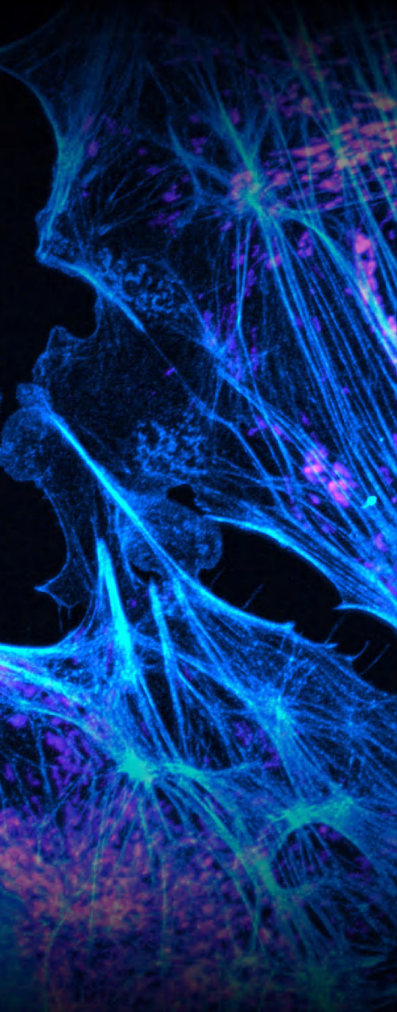

» camera system

maximum frame rate @ full resolution	40 fps
exposure / shutter time	10 $\mu$ s .. 500 ms
dynamic range A/D <sup>4</sup>	16 bit
A/D conversion factor	0.8 e <sup>-</sup> /DN 0.03 e <sup>-</sup> /DN <b>low light mode</b>
pixel scan rate	46.0 MHz
pixel data rate	184.0 Mpixel/s
binning horizontal	x1, x2, x4
binning vertical	x1, x2, x4
region of interest (ROI)	horizontal: steps of 8 pixels vertical: steps of 1 pixels
non linearity	< 0.6 % < 0.4 % (low light mode)
cooling method	passive cooled
trigger input signals	frame trigger, acquire (SMA connectors)
trigger output signals	exposure, busy (SMA connectors)
data interface	USB 3.1 Gen 1
time stamp	in image (1 $\mu$ s resolution)

<sup>4</sup> The high dynamic signal is simultaneously converted at high and low gain by two 12 bit A/D converters and the two 12 bit values are sophisticatedly merged into one 16 bit value.

» general

power delivery	power over USB 3.1 Gen 1
power consumption	typ. 4.5 W (max. 6.0 W)
weight	420 g
operating temperature	+ 10 °C ... + 40 °C
operating humidity range	10 % .. 80 % (non-condensing)
storage temperature range	- 10 °C .. + 60 °C
optical interface	C-mount (optional: F-mount)
maximum cable length	5 m
CE / FCC certified	yes

» frame rate table

2048 x 2048	40 fps
2048 x 1024	80 fps
2048 x 512	159 fps
2048 x 256	302 fps
2048 x 128	527 fps
1920 x 1080	76 fps
1600 x 1200	68 fps
1280 x 1024	80 fps
640 x 480	171 fps
320 x 240	320 fps

selectable input windows available

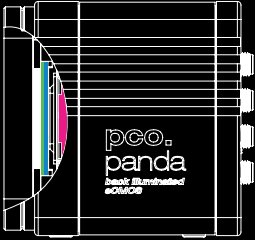

UV+  
input window  
VIS+

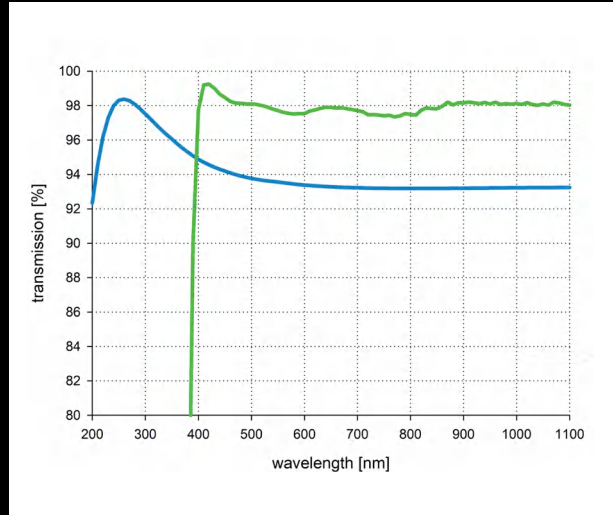

sensor

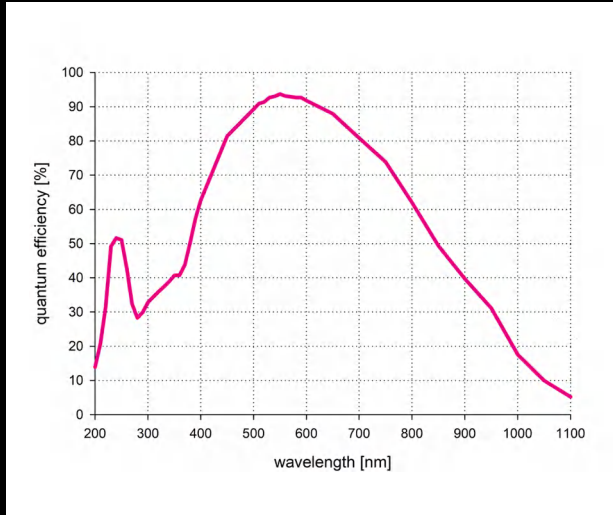

pco.panda 4.2 bi UV camera

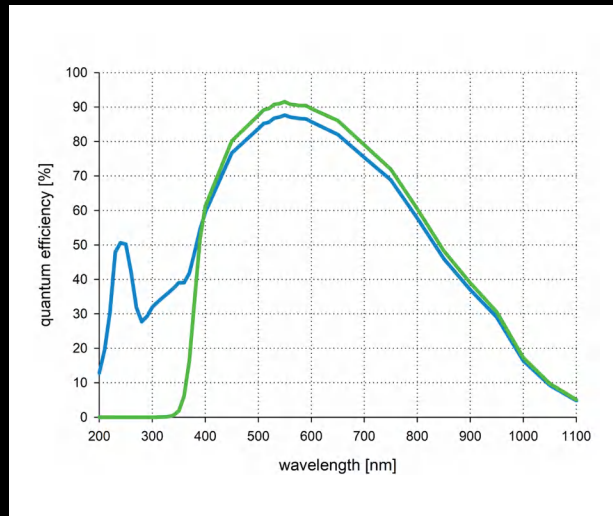

» dimensions

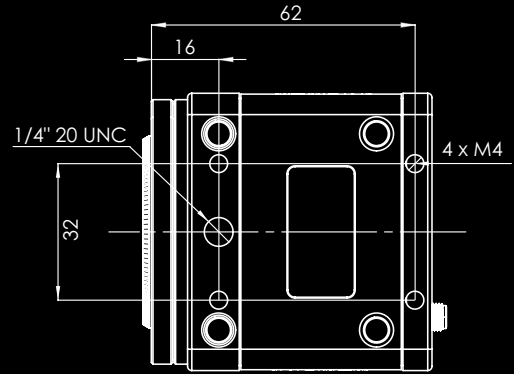
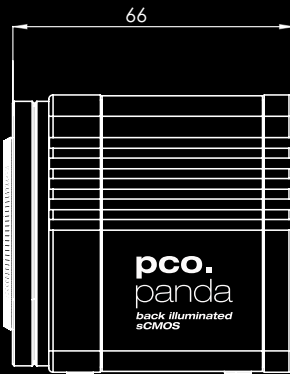
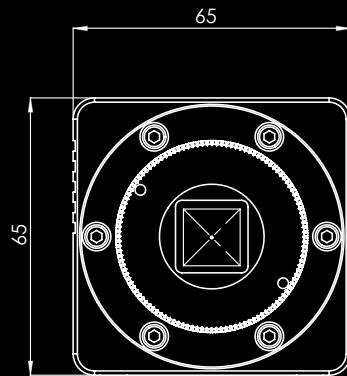

F-mount and C-mount lens adapter are changeable. All dimensions are given in millimeter.

» camera view

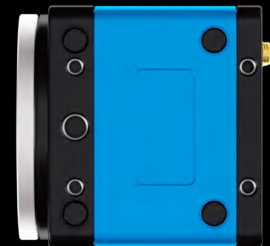
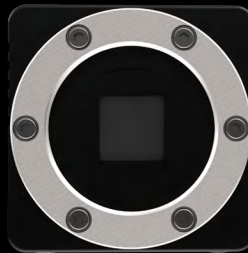

» applications

brightfield microscopy | fluorescence microscopy | single molecule localization microscopy | lightsheet fluorescence microscopy (LSFM) | calcium imaging | FRET | FRAP | high-speed bright field ratio imaging | biochip reading | spinning disk confocal microscopy | ophthalmology | industrial quality inspection

lightsheet scanning mode

low light mode

» software



With pco.camware you control all camera settings, the image acquisition, and the storage of your image data. The pco.sdk is the complementary software development kit. It includes dynamic link libraries for user customization and integration on Windows PC platforms. Drivers for popular third party software packages are also available for you.

All these items like pco.camware, pco.sdk, and third party drivers are free-to-download at [www.pco.de](http://www.pco.de)

» third party integrations



## contact

### pco europe

+49 9441 2005 50  
info@pco.de  
pco.de

### pco america

+1 866 678 4566  
info@pco-tech.com  
pco-tech.com

### pco asia

+65 6549 7054  
info@pco-imaging.com  
pco-imaging.com

### pco china

+86 512 67634643  
info@pco.cn  
pco.cn



for application stories  
please visit our website

official PCO sales partner

**pco.**

subject to changes without prior notice | lens is sold separately  
©PCO AG, Kelheim | pco.panda 4.2 bi data sheet | v1.03



ISO 9001:2015